

Blower Door Operation

Manual

For 300, 5000, 6000, and
7000 Systems



Made by Retrotec
1060 East Pole Road
Everson, WA USA 98247

For support:

Email: support@retrotec.com

Call 1 (888) 330-1345 in USA

+1 (360) 738-9835 outside USA or

Fax +1 (360) 647-7724

Manual for:

Series 300, 5000, 6000, and 7000

Copyright © 2012-2025 Retrotec, All rights reserved.

This document contains materials protected under International and Federal Copyright Laws. No part of this book may be reproduced or transmitted in any form or by any means, electronic or mechanical, including photocopying, recording, or by any information storage and retrieval system without express written permission from Retrotec.

Retrotec makes no warranties with respect to this documentation and disclaims any implied warranties of merchantability, quality, or fitness for any particular purpose. The information in this document is subject to change without notice. Retrotec reserves the right to make revisions to this publication without obligation to notify any person or entity of any such changes.

DucTester, Infiltrometer and FanTestic are Trademarks of Retrotec. Other trademarks or brand names mentioned herein are trademarks or registered trademarks of their respective owners.

Retrotec test fans, blower door systems, duct testing systems and gauges have been calibrated in our laboratory which is accredited by the ANSI-ASQ National Accreditation Board to meet requirements of international standard ISO/IEC 17025:2005. All pressure and flow devices used in the calibration are traceable to the National Institute of Standards and Technology and themselves have ISO 17025 accreditation.

Retrotec equipment and software complies with the following standards:

ASTM E779-10, ASTM E-1554, ATTMA TSL1, ATTMA TSL2, CGSB 149.10, DW/143, Energy Star, EN12237, EN13829, EN15004, FD E51-767, ISO 9972-2015, ISO 14520-2006, NEN2686, NFPA 2001-2015, RESNET, SMACNA-2002, All USA State Energy Codes, Title 24 and USACE Protocol.

Custom calibration available upon request.

Table of Contents

Important equipment-related safeguards.....	6
Important occupant safeguards during testing	7
1. How the Blower Door System components work	8
1.1 How the Calibrated Fan creates flow and Fan Pressure.....	9
1.2 Range configurations restrict the fan’s air flow	10
1.3 The Door Panel seals off a doorway and provides a fan mount.....	11
1.4 Gauge measures two pressures during the test.....	11
1.5 A Fan Speed Controller sets the test pressure	13
1.5.1. Use Speed Control Knob on the fan.....	13
1.5.2. Control fan speed with a DM32X or DM32 gauge	13
1.6 Model 5000 for testing homes	14
1.7 Model 6000 and 7000 high flow fans	14
1.8 Model 300 fans for tight houses.....	15
2. Choose a Door Panel based on size of door and fans	17
2.1 Cloth Door Panel with Aluminum Frame.....	17
2.1.1. Using the Aluminum Frame	18
2.1.2. Available Aluminum Frame Part Replacements	19
2.2 Modular Hard Sided Door Panels	20
2.2.1. Modular Door Panel Instructions.....	21
2.2.2. Compensating for Panel Leakage.....	21
2.3 Stacking Panels for multiple fan tests	22
2.3.1. Using the Stacking Panels	23
2.4 Installing panels in double doorways	25
3. Conduct a Test	26
3.1 Observe house to avoid problems during testing	26
3.1.1. Ashes and other materials can blow into house.....	26
3.1.2. Doors can slam shut.....	26
3.2 Select a Location.....	26
3.3 Where to place the exterior Pressure pickup tube(s)	26
3.4 Determine if corrections for temperature difference are required	27
3.5 Install the Door Fan for Depressurization test	28
3.6 Set up the Gauge for the Appropriate Test	28
3.7 Connect a Fan to the gauge (DM32X/DM32)	28

3.8	Select the correct Range configuration	30
3.9	Determine which Range to use on a Door Fan	30
3.10	Cannot reach required pressure?	31
3.11	Choose either a Single or Multi- Point Test Procedure	31
3.12	Taking Manual Single Point Readings	31
3.12.1.	Measure the Baseline Pressure before turning the fan on.....	31
3.12.2.	Adjust your test fan manually	32
3.12.3.	Adjust your test fan using Set Pressure	32
3.13	Taking Manual Multi-Point Readings for FanTestic Software	33
3.13.1.	Decide how many test points to take	33
3.13.2.	Decide whether to test in both directions.....	34
3.13.3.	Decide what is the optimum opening size on the fan (Range).....	34
3.13.4.	Measure the Baseline (Zero Flow) Pressure before the test	35
3.13.5.	Measure each of the target points required for the test	35
3.13.6.	Complete taking the data set for this direction.....	36
3.13.7.	Take another data set with fan flow in the other direction	36
3.13.8.	Enter collected data into FanTestic to get Results	36
3.14	Completely automated results using FanTestic	38
3.15	Basic Results from Single Point Test.....	39
3.15.1.	Air Leakage at 50 Pascal.....	39
3.15.2.	Air Changes per hour at 50 Pa - ACH50	40
3.15.3.	Equivalent Leakage Area - EqLA 10.....	40
3.15.4.	Effective Leakage Area - EflA 4.....	40
3.16	Results from Multi-Point Procedure.....	40
4.	Avoid Common Sources of Error.....	41
4.1	Wrong Range Configuration or Device	41
4.2	No Reference Tube when Pressurizing.....	41
4.3	Incorrect @ Pressure usage.....	41
4.4	Choose the Appropriate Test Direction.....	41
4.5	Minimize effects of upstream Air Flow conditions.....	41
4.6	Considerations when operating with high backpressure	42
4.7	Wind effects on test fan accuracy	42
4.8	Enclosure pressure measurement disturbances	44
5.	Power to run the fan and gauge	45
5.1	Status lights indicate power and control connections are ready to go.....	45

5.2	Using the Fan with Mains Power	45
5.3	Using the Fan with a power generator	45
5.4	Recommended Generators	46
5.4.1.	Honda Generator EU2000 (120V, 2000W, 67 lbs)	46
5.4.2.	GENYX G3000HI (230V, 3000W) generator	47
5.5	Portable Power Supplies for DucTester.....	47
5.5.1.	Black and Decker Electromate 400 Model VEC026BD	47
6.	Maintenance and Field Checks	48
6.1	Pre-test checks.....	48
6.2	Check motor and fan blade position	48
6.3	Check for Flow Sensor leaks	49
6.4	Check Fan for blockages	51
6.5	Check maximum flow on Open Range.....	51
6.6	Checking the fan blade clearance.....	51
6.7	Perform a field verification monthly	52
6.8	Most common cures.....	52
	Appendix A: Calculate Airflow Manually	54
	Appendix B: Find correct CFM at particular fan pressure	55
	Fans & Accessories	55
	Regular Aluminum Frame.....	57
	Window (small) Aluminum Frame.....	57
	Oversize Aluminum Frame	57
	Cloth Door Panels	59
	Modular Door Panels.....	60
	Digital Gauges	63
	System Accessories.....	63
	Appendix C: Optional Door Fan system components	66
	Flex Duct to measure air flow or neutralize pressure drops	66
	Wind Damping Kits to minimize wind effects.....	66
	Cases and Bags.....	67
	Using Retrotec Blower Door with QuietCool Whole House Fan Powered Flow Hood.....	67
	Appendix D: Model and System Names	68
	Glossary.....	74

Important equipment-related safeguards

READ AND SAVE THESE INSTRUCTIONS

When using electrical appliances, basic safety precautions should always be followed. If Retrotec equipment is used in a manner that does not follow the information provided in this manual, safety to the operator and equipment performance may be impaired.

The risk of fire, electric shock, and injury to persons may result during cleaning and user-maintenance of the fan. To avoid these risks, unplug or disconnect the fan from the electrical power supply before servicing. Any and all safety devices removed for any reason shall be reinstalled or remounted as previously installed before plugging the fan into electrical power.

To protect against the risk of fire, electric shock, and injury to persons during fan operation:

Do not operate any fan with a damaged electrical cord. Discard fan or return to an authorized service facility for examination and/or repair.

Do not run cord under carpeting. Do not cover cord with throw rugs, runners, or similar coverings. Do not route cord under furniture or appliances. Arrange cord away from traffic area and where it will not be tripped over.

Do not place this equipment or power cord in water or other liquid.

Use only the included power plug to operate the fan. Do not use ungrounded outlets or adapter plugs. Never remove or modify the grounding prong.

Turn the unit off and unplug from electrical outlet before moving and when not in use, and when making any adjustments to the fan motor, blades or electrical components.

For use under indoor conditions only, where there is no exposure to water or dusty substances or explosive materials or flammable materials.

Do not use equipment for other than its intended use.

Equipment is intended for diagnostic testing and to be operated for brief periods under supervision by a qualified operator. Not to be used in a role as a household appliance for the purpose of moving air. The fan is designed to be used while mounted in the Door Panel.

At high-speed, the fan can tip over if not secured properly. The fan can cause damage or injury if it were to fall on someone/something.

Do not stand on the fan, or use the fan to support the weight of another object.

Press the power plug firmly into the power receptacle on the fan. Failure to do so can cause over-heating of the power cord and damage the fan.

Avoid contact with moving parts. Keep hands, hair and clothing away from fan at all times. Special attention should be made to keep children and pets away from the fan when it is operating.

Do not insert anything into the fan casing while the fan is moving.

Ensure that no debris is inside the fan casing before operating the fan.

Ensure proper cooling of the fan motor.

If the motor gets too hot, the thermal overload protection will shut-down the fan. When this happens, turn the controller off, so that the fan does not restart unexpectedly after it cools down.

During prolonged operation, such as when maintaining building pressure while air-sealing, use Range Ring A.

Failure to follow these instructions carefully may result in bodily injury, damage to property and/or equipment failure. Failing to operate equipment as intended may void warranty and compliance with CE mark and other listings.

Important occupant safeguards during testing

Please read the following carefully before carrying out tests:

The fan can move a significant amount of air, causing papers or other light flat objects such as pictures to be thrown around. Ensure that loose items are secured.

If dust, pollen, mold spores, chemicals, asbestos, vermiculite dust, fiberglass dust, cellulose dust, lead paint dust or other undesirable substances can get blown into living spaces, keep those susceptible to these substances away from the test area, and wear dust masks or do not test.

Do not pressurize an enclosure with air that is polluted or exposed to any toxic substances. For example, blowing air from a garage into a house while a motor vehicle is running can quickly fill a house with toxic carbon monoxide.

Cover exposed ashes or test at or below 25 Pa to avoid blowing ashes from open fire pits.

Do not pressurize a duct system with air that is polluted or exposed to any toxic substances. For example, blowing air from a car-port into a house or duct system while a motor vehicle is running can quickly fill a house with toxic carbon monoxide.

Air sealing duct work may change the pressure balance in a house and cause back drafting where it did not occur before. For example, a return leaking to outdoors may have pressurized a house but when corrected, leaky supplies may reverse that and cause depressurization which could result in back drafting hot water heaters, furnaces or fireplaces.

Be aware of all possible sources of combustion. Ensure any appliances do not turn on during the test. Turn off power to the appliance, or set the appliance to the "Pilot" setting. It is possible for flames to be sucked out of a combustion air inlet (flame rollout) during a test, which is a fire hazard and can result in high carbon monoxide levels.

If there are attached spaces (e.g. townhouses) that could contain a vented combustion appliance, either adjust those appliances to prevent them from turning on during the test, or be sure that the attached spaces are not depressurized or pressurized when the Door Fan is operating.

If combustion safety problems are found, tenants and building owners should be notified immediately and steps taken to correct the problem (including notifying a professional heating contractor if basic remedial actions are not available). Remember, the presence of elevated levels of carbon monoxide in ambient building air or in combustion products is a potentially life threatening situation. Air sealing work should not be undertaken until existing combustion safety problems are resolved, or unless air sealing is itself being used as a remedial action.

Failure to follow these instructions carefully may result in bodily injury, damage to property and equipment failure.

1. How the Blower Door System components work

A Door Fan is a specially designed calibrated fan which, as part of the Blower Door Fan System, is temporarily mounted in a doorway. The fan is used to blow air into or out of a room, house, or building to measure the air leakage of the enclosure. The terms room, house, or building are often classified as the “enclosure” for airtightness testing purposes.

The Door Fan System works by establishing a pressure difference between the inside and the outside of an enclosure. The pressure difference forces air to leak through all of the holes in the exterior envelope of the enclosure. The amount of air flow that is required to maintain a constant pressure difference is equal to the amount of air that is leaking from the enclosure. A specially designed gauge can thus be used to measure the pressure difference and calculate the amount of air flowing through the Door Fan, which can then be used to determine the total size of all those leaks.

A typical Door Fan or Door Fan system is comprised of four main parts:

1. A Door Panel, which temporarily seals a typical doorway and provides a hole to mount a fan.
2. A calibrated fan, capable of creating a measurable flow of air.
3. A two-channel differential pressure gauge that can also calculate flow for a particular fan.
4. A fan speed controller to change the air flow through the fan (which can be provided by the gauge)

A typical Door Fan system breaks down as shown in Figure 1:

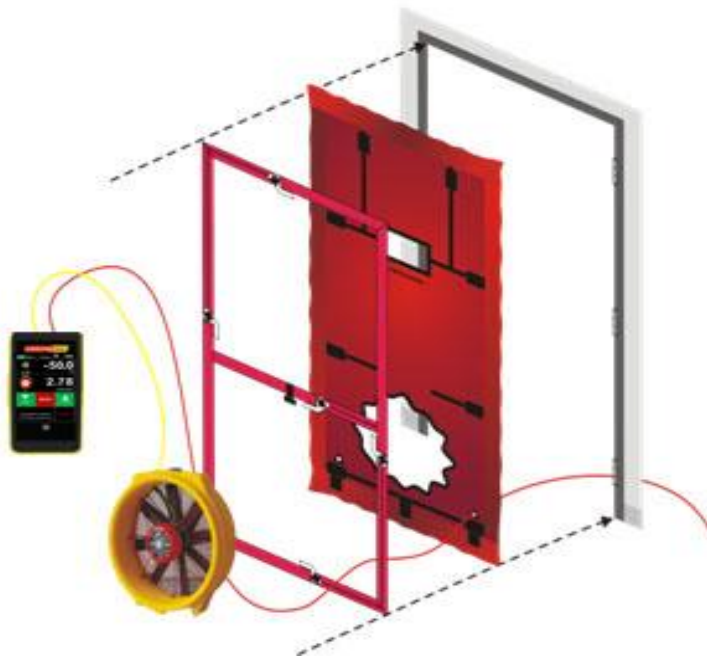

Figure 1: The breakdown of a typical Door Fan system.

In this case, an aluminum frame holds a Cloth Door Panel in place, sealing the doorway. The fan is mounted in the hole in the cloth, and is supported by the aluminum frame crossbar. The gauge is acting as both the fan controller and differential pressure gauge.

In its role as differential pressure gauge, one channel of the gauge is connected to the fan through a yellow tube to measure the Fan Pressure, (referenced to the pressure at the green port of the gauge), which is the pressure required for the fan to bring the enclosure to the desired pressure. The other channel of the gauge is measuring the pressure difference between the area in which the gauge is located (on the blue port of the gauge) and the other side of the doorway, since the red tube connects to the other side of the doorway and acts as a reference for the measurement.

In its role as a fan speed controller, the gauge is connected to the fan through an electrical connector, (yellow Speed Control Cable), and changes the speed of the fan until the pressure difference across the doorway reaches the desired test condition. The Speed Control Cable can extend approximately 1,200 meters (4,000 feet) between the gauge and the fan.

Knowing the pressure difference tells the operator when the enclosure has reached the desired condition (50 Pa for instance). Knowing the Fan Pressure and the fan calibration allows the operator, or the gauge itself, to calculate the air flow (CFM for instance).

1.1 How the Calibrated Fan creates flow and Fan Pressure

When the fan is turned on, air starts moving through the fan housing. In order for the air to be pulled through the holes on the inlet side, there must be suction. The rotating fan blade creates a suction pressure (which is also called Fan Pressure) between the inlet opening and the fan blade. Range Rings and Plates are typically installed on the inlet side of the fan housing to artificially restrict flow, control the amount of air going through the fan, and thus control the Fan Pressure.

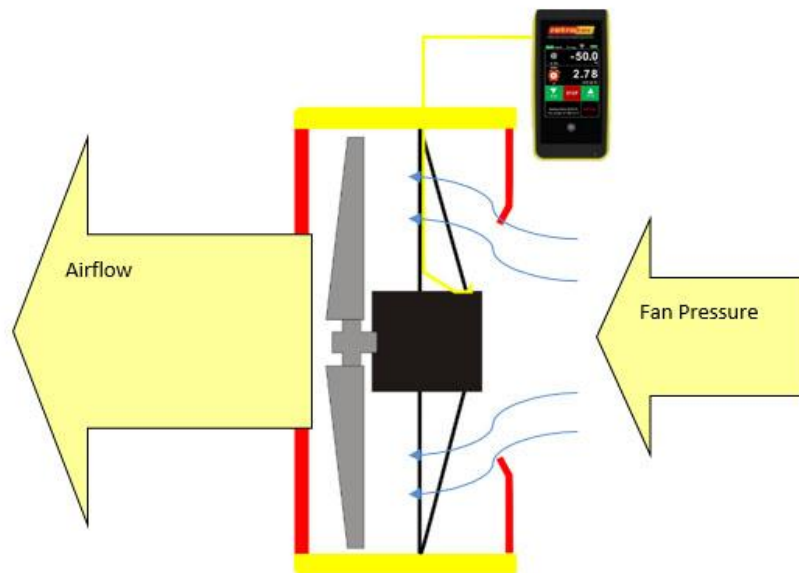

Figure 2: Pictorial display of how a calibrated Door Fan works.

By measuring the Fan Pressure developed across the fan housing, and knowing the size of the hole(s) in the installed Range, we can calculate the volume of air moving through the fan.

When flow is away from the operator, the Fan Pressure signal will always be correct and will not need adjusting. The gauge can determine if flow is away from the operator because pressure

When the flow is towards the operator, the Fan Pressure reading is affected by the pressure in the area into which the air is flowing. The area which is being pressurized will exert pressure at the gauge's green port, which will be picked up and included as part of the measured pressure difference. The measured Fan Pressure, shown when Pressure is the Result being displayed on the gauge, will thus include the actual Fan Pressure as well as the additional pressure in the room where the operator is standing. So when the flow is towards the operator, this room pressure must be removed from the measurement to get the true Fan Pressure, before calculating flow.

A self-referencing fan avoids the need for adjusting Fan Pressure measurements by measuring the pressure difference at the fan inlet directly with both the green and yellow tubes connected to either side of the fan inlet on Retrotec fans. The Fan Pressure difference is thus always correct when measured between the yellow and green port at the gauge.

The gauge can determine when flow is toward the operator because the readings on Channel A will always be positive (assuming the gauge is set up with the blue port measuring the pressure of the room in which the operator is standing, and the red tube runs to the opposite side). Thus, if a device that is not self-referencing is chosen on the gauge, (any device except the Model 300 and those denoted SR), and Channel A readings are positive, the gauge compensates: the measured pressure from the fan, "PrB", is reduced by the room pressure being measured on Channel A, "PrA". The gauge then uses the adjusted value, the actual Fan Pressure, to calculate the airflow displayed as Mode "Flow" or any other Mode result except "PrB". When the Mode is set to "PrB", the gauge always shows the actual pressure difference measured on Channel B, which includes both the fan pressure and the additional pressure in the room where the operator is standing, when flow is towards the operator.

Other manufacturers' digital gauges need to have the pressure signal from the fan corrected to the actual Fan Pressure before the Fan Pressure value is used to calculate air flow. When flow is towards the operator, the procedure is to subtract the Room Pressure from the Fan Pressure to determine the actual Fan Pressure.

1.2 Range configurations restrict the fan's air flow

A Door Fan measures flow by measuring the Fan Pressure (usually on Channel B of the gauge). As the fan blades spin, a suction pressure develops in the fan that causes air to flow. By measuring this suction pressure (Fan Pressure), airflow can be calculated.

When there is not much air flow through the fan, the Fan Pressure becomes too small to accurately measure. To bring the Fan Pressure up into a more accurate range, while not changing the volume of air being moved, a restriction is placed in front of the fan. Because of the restricted area through which to move air, the fan has to spin faster to move the same volume of air. The suction or Fan Pressure thus increases to where it can be accurately measured again.

The calibrated fans are provided with a set of Ranges which are metal rings and plates with holes in them. Each inlet size has a pre-established range of air flows that it will allow the calibrated fan to accurately measure.

Range Configurations are somewhat analogous to gears in a standard transmission. The lower the air flow, the smaller the hole required to maintain a readable Fan Pressure.



Figure 3: Range Configuration components for 300 series fans (left) and 5000 / 6000 / 7000 fans (right)

See section 3.8 and 3.9 for details on how to select the correct Range Configuration for the test.

1.3 The Door Panel seals off a doorway and provides a fan mount

Retrotec offers three types of Door Panels. The most common style of Door Panel is a Cloth Door Panel on an aluminum frame. Modular Door Panels are a set of solid panels that expand to fit most doors, and offer a quick setup or take down option that is professional looking and easy to carry. For large buildings, three fans can be mounted in one Three-Fan Panel, to maximize the airflow pushed through one doorway.

See section 2 for details on each type of Door Panel, and set up instructions.

1.4 Gauge measures two pressures during the test

The Retrotec digital gauges (DM32X/DM32) are two channel differential pressure gauges. A differential pressure gauge measures the pressure difference between two locations. The gauge provides two channels, each of which can measure a pressure difference (between 2 ports). Channel A measures the difference in pressure between the blue and red ports, and Channel B measures the pressure difference between the green and yellow ports.

In its role as a two channel differential pressure gauge during the Blower Door test, one channel of the gauge is used to measure the Fan Pressure and one channel is used to measure the Room or Induced Pressure. The Fan Pressure is the pressure inside the fan that is developed while the fan brings the room to the test pressure. The Room or Induced Pressure is the pressure difference between the area in which the gauge is located, and the other side of the Door Panel.

To measure the Fan Pressure difference between the fan interior and the fan exterior, the yellow port on the gauge is connected to the fan through a yellow tube. If the fan provides a green port (fan is self-referencing), the green port on the gauge should also be connected to the green port on the fan.

To measure Room Pressure, the red tube is connected to the red port on the gauge and then run through a small hole in the cloth to the other side of the Door Panel. If using the SmartCloth instead of a traditional cloth, the red tube is connected to an insert instead of using the small cloth hole. The blue port on the gauge is open to the pressure in the room so the difference between the pressure in the room and the other side of the Door Panel is measured on Channel A.

It is very simple to connect a Retrotec fan to the digital gauge. Depending on which model fan is in use, there will be some combination of red, blue, green, and yellow pressure tubes included. These tubes connect to their corresponding color coded ports on the gauge. The Speed Control Cable connects to the port marked "Speed Control", and can be up to 1200 m (4000 ft) long.

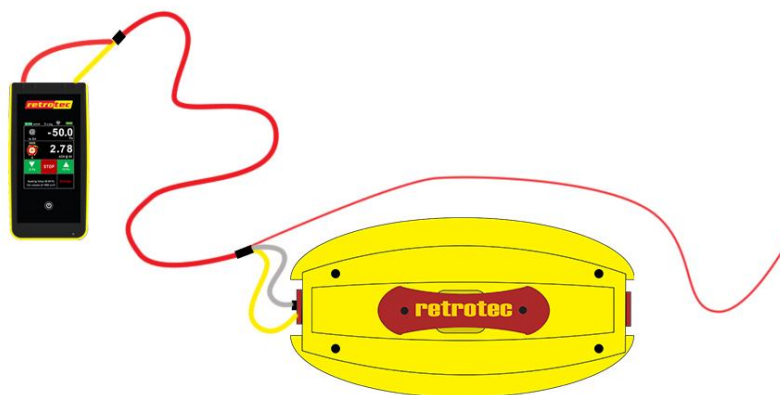

Figure 4: DM32/DM32X to fan connection.

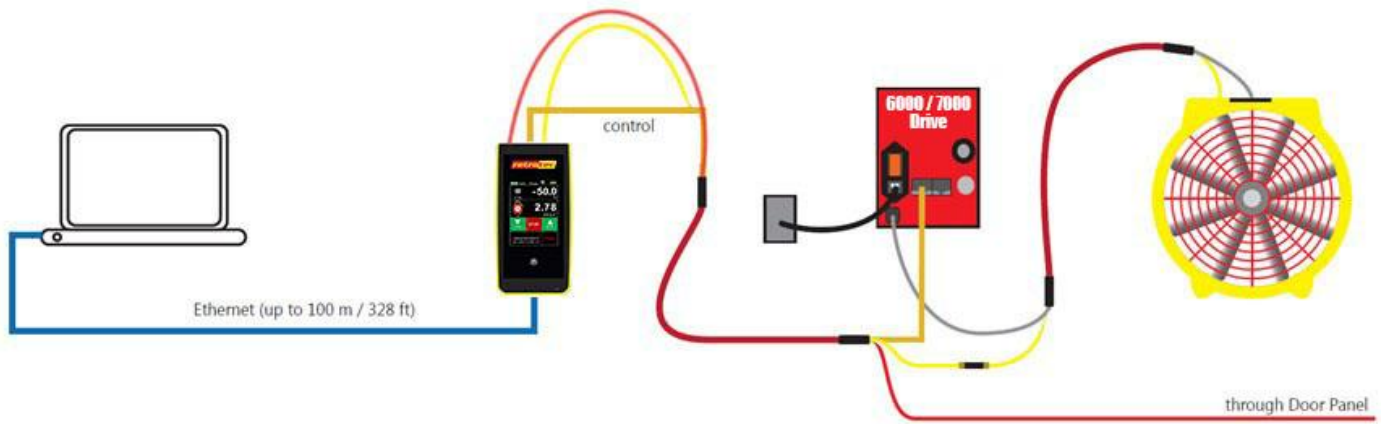

Figure 5. Connections between a 6000 / 7000 Door Fan, Drive, DM32 gauge, and laptop. Dimensions are not shown to scale.

For Multi-fan setup configurations, refer to the *Multiple Fan Operation Testing Manual*.

1.5 A Fan Speed Controller sets the test pressure

If operating the Blower Door Fan System manually, a knob on the fan or a Manual Speed Control accessory allows the speed of a fan to be controlled by turning a knob/dial. Otherwise, speed can be controlled from the gauge.

The gauge can operate as a fan speed controller in addition to being a two channel differential pressure gauge. In its role as a fan speed controller, the gauge is connected to the fan through an electrical control connector and changes the speed of the fan until the pressure difference across the doorway reaches the desired test condition.

The Fan Speed Control output on the gauge speed control cable which connects to the fan uses RS-485 protocol. This protocol allows the Speed Control Cable to extend approximately 1,200 meters (4,000 feet) between the gauge and the fan.

A speed control splitter can be used to control more than one fan with a single gauge.

1.5.1. Use Speed Control Knob on the fan

Some fans provide a Speed Control Knob on the Fan Top which allows the user to manually control the speed of the fan. Set the fan speed to zero by adjusting the Speed Control Knob as far as it will go, counter clockwise.

1. Turn the Door Fan power on.
2. Slowly adjust the knob clock-wise, to accelerate the fan.



1.5.2. Control fan speed with a DM32X or DM32 gauge

1. Connect the included Speed Control Cable from the Fan Top to the port on the gauge (labeled “Speed Control”). The cable provided by Retrotec is specially wired to prevent interference between the fan and gauge, but if unavailable, any standard CAT5 or CAT6, Ethernet-style cable can be used.

Some fans have more than one speed control port on the Fan Top. In these cases, additional Speed Control Cables can be used to link multiple fans together, with the primary fan being connected to the gauge. This will allow one gauge to control the fan speed of all fans in a chain, called “daisy-chaining the fans”.

2. If the battery power is too low, connect the DM32X/DM32 power cable (in the Umbilical) from the power outlet on the Fan Top to the power input on the gauge. Some model fans do not have this option, in which case the gauge would have to be connected to a power outlet using the provided power adaptor.

1.6 Model 5000 for testing homes

The 5000 model fan is a basic $\frac{3}{4}$ horsepower fan with built in speed control and dual Control Ports. Multiple fans can be daisy chained together, and simultaneously controlled by a single DM32X or DM32 Digital Pressure Gauge. Speed can be controlled via the gauge, or manually controlled with the knob on the Fan Top.

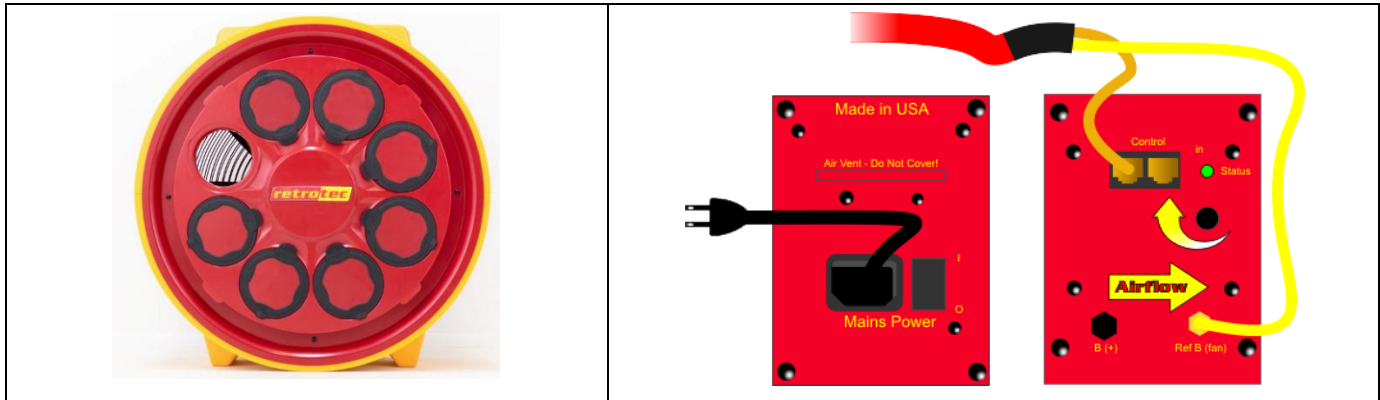

Figure 6: Model 5000 fan with two electrical plates containing power connection and switch, dual Control Ports and manual speed knob.

To connect the 5000 to the DM32X/DM32 Digital Pressure Gauge

1. Connect the power cord from the fan to a compatible wall outlet.
2. Connect one end of the yellow tube from the Umbilical to the yellow port on the fan labeled "Ref B" and the other end to the yellow port on the gauge labeled "Ref B (-)".
3. Connect the Speed Control Cable from the DM32X/DM32 "Speed Control" port to the left "Control" Port on the fan.

1.7 Model 6000 and 7000 high flow fans

The 6000 and 7000 fans are fans suitable for residential and commercial testing. The fans are fully automatic and can be controlled through the DM32X/DM32. They include a variable speed drive which is a red box (for Model 6000 fans) or a black/yellow box (for Model 7000 fans) containing a 3-phase power supply.

Ensure that a dedicated 20A circuit is available for each fan. Stove top electrical outlets are an ideal 20A circuit to which to connect the 6000 or 7000 fans. Do not operate multiple 6000 or 7000 fans on the same circuit, since each fan at maximum speed can draw up to 20.4A. Do not operate other loads on the same circuit as the fans during the test. Doing so may cause the circuit breaker to trip.



Figure 7.1 Model 6000 fan and Drive.







Figure 8.2 Model 7000 fan and Drive.

To connect 6000 / 7000 fan models to the DM32X/DM32 Digital Pressure Gauge

1. Connect Speed Control Cable from the DM32 umbilical to the Control Port on the variable speed drive (red or black/yellow box containing power supply).
2. Connect the pressure tubes from the DM32X/DM32 umbilical to the matching-color ports on the variable speed drive (some drives do not have color-coded ports – in these cases, attach using pressure port naming conventions on the DM32X/DM32). If the variable speed drive does not have pressure ports, connect the color-coded tubes to the matching colored tubes on the Fan umbilical.
3. Connect the power cord from the variable speed drive to a 20A compatible wall outlet. The 3300 fan draws a significant amount of power; no other devices can be running on the same circuit.
4. Connect a pressure tube from the “Ref B” (yellow) port on the variable speed drive to the “Ref B (-)” (yellow) port on the DM32X/DM32.
5. If available, connect a second pressure tube from the “Input B” port (green) on the variable speed drive to the “Input B (+)” (green) port of the DM32X/DM32.
6. Connect the Speed Control Cable from the umbilical to the “Speed Control” port on the DM32X/DM32.

1.8 Model 300 fans for tight houses

To turn a duct testing system into a Door Fan system for testing tight, you only need to add an Aluminum Frame and a Low-Flow Cloth Door Panel.

			
<p>The Model 200 blower door system has 0.25 HP, which can move between 7 and 725 CFM. It is the predecessor of the Model 300.</p>		<p>The Model 300 is ideal for testing tight houses as large as a 1600 square feet of floor area that leak as much as 3 Air changes per Hour.</p>	

The Retrotec 300 fan is recommended for testing tight enclosures. The 300 fan is not available on the DM-2 gauge. On the DM32X/DM32 gauges, you must choose the device called 300 on the Retrotec Blower Doors screen so that the correct n value is used in the calculation of @Pressure in the gauge.

The hookup can be the same as the Model 5000 as long as the fan is blowing away from the operator as it would be for depressurizing from inside the enclosure. When the fan is blowing towards the operator, the green port between the fan and gauge MUST also be connected to reference the fan properly otherwise the flow will read extremely high. To avoid any issues, it is recommended that both the yellow and green tubes are connected at all times between the gauge and the fan. Door Fan systems for testing tight enclosures should be set up as shown in Figure 9 below.

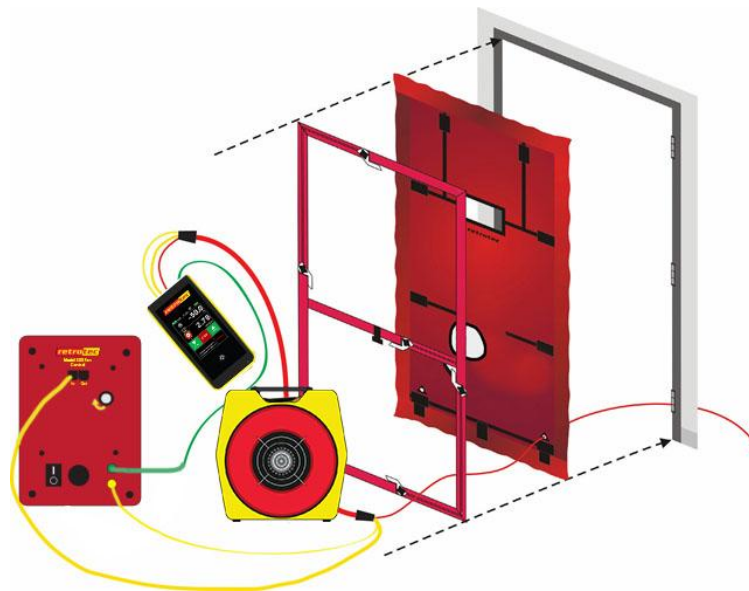

Figure 9: Door Fan setup using a Model 300 fan to test tight enclosures. The left image shows the Fan Top from a side view of the Model 300 fan with tubing and Control Cable connections.

Note: The green tube must be connected if the flow is towards the operator (i.e. air is blowing towards where the operator is standing), and is recommended to be connected at all times so the correct Fan Pressure is used in all calculations under all circumstances.

The Speed Control Cable can be plugged into either one of the two Control ports on the fan. a

For Door Fan testing, refer to procedures outlined in section 3.

2. Choose a Door Panel based on size of door and fans

Retrotec offers three types of Door Panels. The most common style of Door Panel is a Cloth Door Panel on an Aluminum Frame. Modular panels (or Modular Door Panels) are a set of solid panels that expand to fit most doors, and offer a quick setup or take down option that is professional looking and easy to carry. For large buildings, three fans can be mounted in one Three-Fan Panel, to maximize the airflow pushed through one doorway.

Only 5000, 6000, and 7000 Series fans will fit properly in the Hard Modular Panel but they must have a label on the fan stating it will fit properly in the Hard Panel.

2.1 Cloth Door Panel with Aluminum Frame

A Cloth Door Panel with aluminum frame is standard with the Q46, Q56, and 1000 Door Fan systems. If purchased separately, the Cloth Door Panel can be used with most Retrotec fans.



Figure 10: Cloth Door Panel types

Retrotec's aluminum frame comes with a Standard Cloth Door Panel, which can fill a door up to 41.5 inches wide by 95 inches high. However, some applications may require that a different Cloth Door Panel be used with the aluminum frame.

Larger doorways will require the Aluminum Frame Extender Kit, and an Extra Tall Extra Wide Cloth Door Panel. With the extension kit and panel, the maximum door frame width is extended to 48in and the maximum height becomes 110in.

Extender kits increase the size of doorway that can be fit with the aluminum frame. An extender kit consists of vertical and horizontal extenders, a crossbar extender, plus an additional crossbar (#6 Upper crossbar, and extender). Also included is the Extra Tall, Extra Wide Cloth Door Panel.

Table 1: Aluminum frame door panel dimensions.

	Dimensions	With Extender Kit
Panel width	29.5 - 41.5 in (75 - 105.4 cm)	30 - 48 in (76 - 122 cm)
Panel height	51.5 - 95 in (131 - 241 cm)	60 - 105 in (152 - 267 cm)
Frame thickness	1.75 in (5.3 cm)	
Frame case	53 x 10 x 4 in (134 x 25 x 10 cm)	
Frame weight	14.2 lbs (6.4 kg)	

A Hi-Pressure Cloth Door Panel is required if testing is expected to exceed 150 Pa (rated for tests at pressures up to 300 Pa). The Hi-Pressure cloth includes additional security straps to hold the fan in place. Adding an additional crossbar is also recommended for high-pressure tests.

Two fans can also be mounted in a single aluminum frame with the addition of a second crossbar and a Double Fan Cloth Door Panel.

A Low-Flow Fan Cloth Door Panel is used to test tight enclosures with a Model 300 fan.

2.1.1. Using the Aluminum Frame

The Retrotec Aluminum Frame is quick and easy to assemble. The ends of each piece are numbered; match the numbers to connect each piece build the frame.

The frame consists of the following parts:

- 1 - #2/3 right side piece
- 1 - #1/4 left side piece
- 1 - #1/2 top end piece
- 1 - #3/4 bottom end piece
- 1 - #5 Lower crossbar with fan strap
- 1 - #6 Upper crossbar with fan strap

Each piece has a black rubber knob which, when loosened, permits the piece to be adjusted in length. The white plastic, tightening Cam Lever expands the frame a small amount, to provide a tight fit when in the doorway.

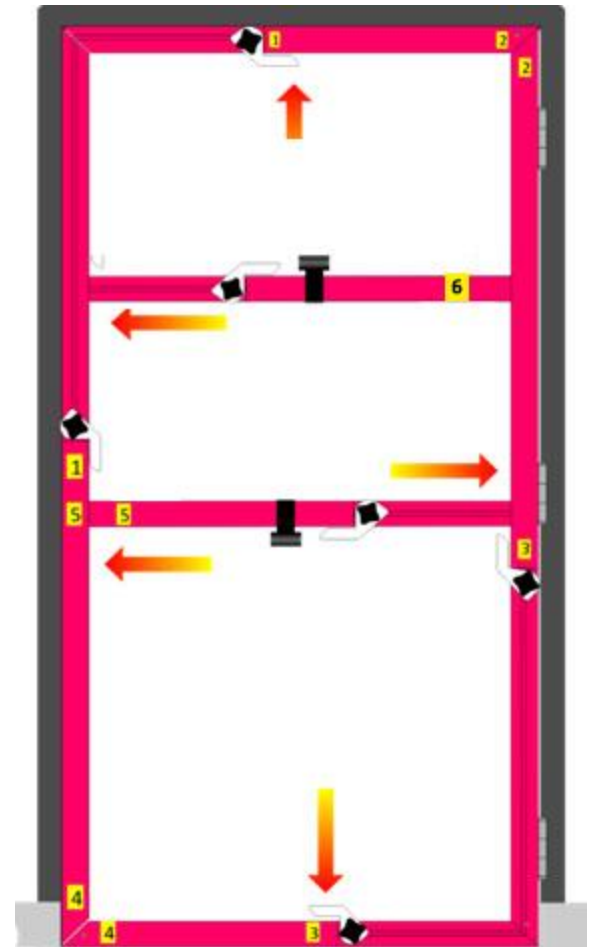

Figure 11: Aluminum Frame for the cloth fan door panel.

To assemble the Aluminum Frame

1. Attach the frame pieces so that the matching numbers are aligned. The small metal button may need to be depressed slightly to slide the pieces in. The button should pop back out into the matching hole when the frame pieces are correctly aligned.
2. Flip all of the white cam levers to the off position (flat against the channel).
3. Install the #5 Lower crossbar into the side pieces at the location stamped "5".
4. Install the #6 Upper crossbar into the side pieces at the location stamped "6".
5. Place the frame in a doorjamb, with the black rubber knobs exposed. Loosen the black knobs to allow height adjustment of the frame, and raise the top of the frame (while holding the lower part down with a foot) until it is in contact with the upper inside of the jamb. Tighten both side knobs.
6. Loosen all the horizontal adjustment knobs (on the top and bottom and crossbar frame pieces) and adjust frame width until it is in contact all along both sides of the doorjamb. Now tighten the horizontal knobs.
7. Remove the frame from the doorway.

8. Put the cloth cover on the frame. Put the bottom of nylon cover around the bottom of the frame and connect the Velcro strips. Bring the nylon cover up and around the top of the frame and connect the top Velcro strips. Wrap the panel around the side, and connect the final Velcro straps.
9. Put the covered frame back in the door opening. Turn all five of the white plastic cam levers to the “expand” position (away from side of channel) to lock it into place.
10. Ensure that the panel is solidly anchored in position. If it needs to be tighter, release the cam levers one at a time, loosen the knob, push the frame into position, tighten the knob, and re-actuate the cam lever.

To remove the frame

1. Release all five white cam levers. Pull the frame from the doorway. It may be necessary to loosen some of the black knobs if the frame was secured tightly in the doorway.
2. Lay the frame flat on the ground, and lean it against a wall.
3. Remove the cloth, and fold it for easy packing.
4. Loosen the black knobs and collapse the frame to its smallest size. The frame can be transported in this fashion, partially assembled, by re-tightening all of the knobs.
5. To disconnect the frame, push the metal button in while pulling the frame pieces apart.

To install a fan in the Cloth Door Panel

1. Determine which direction the air is required to flow, and align the fan according to the airflow indicator on the Fan Top panel. Airflow into an enclosure pressurizes the enclosure, and airflow out of an enclosure depressurizes.
2. Hook the bottom of the fan into the cloth fan hole.
3. Guide the elastic ring of the fan hole around the fan casing. The elastic around the fan hole can be tightened, if required, on some versions of the Cloth Door Panel. A tight fit is required to prevent air leakage.
4. Use the Velcro fan strap on the horizontal crossbar to hold the fan in place. The elastic should not be supporting the weight of the fan.
5. Double-check that the fan airflow is in the correct direction. It will be much harder to switch the fan around once all of the equipment has been connected.



Figure 12: Installing a fan in the cloth door panel.

2.1.2. Available Aluminum Frame Part Replacements

It is possible to replace damaged or broken parts of the Aluminum Frame. The following pieces can be replaced:

Cam Levers

Knob

Channel Guides

Corner Block

Expander Block

Weather Strip (rubber part around outside edge)

To order replacement parts, reference the part number in Appendix C.

2.2 Modular Hard Sided Door Panels

A Modular Door Panel is standard with three Door Fan systems: models 5000, 6000, and 7000 (see Appendix E for conversion of the old model names to the new ones). If purchased separately, the Modular Door Panel can be used with 5000, 6000, and 7000 fans. A special adaptor plate is also available to incorporate Retrotec's low-flow (DucTester) fans for use with the modular panel.



Figure 13: Modular door panel set.

The modular panel consists of the following parts:

- 1 only Fan Panel with fan strap
- 1 only Large-X panel
- 1 only XY panel
- 2 only Fan Panel fill sheets (one large, one small)

Additional panels, including a Small-X panel, can be purchased to increase the maximum doorway height that the modular panel is capable of filling.

Overall outside dimensions (OD) for the Modular panels:

Model:	PN201
Type of Panel:	Hard Panel (Single Fan)
Width (min/max):	32" – 48.75" (81 - 124 cm)
Height (min/max):	76.5" - 87" (194 - 221 cm)
Panel Case (included):	31" x 30" x 7" (79 x 76 x 18 cm)

PN210R Large X-Panel: $27 \frac{3}{4}"H \times 29 \frac{5}{8}"W$ closed, $51"W$ open

PN211 XY Panel: $19 \frac{1}{2}"H \times 29 \frac{5}{8}"W$ closed, $52"W \times 30"$ open

PN207 Large Fill-in Sheet for Fan Panel: $27"H \times 17 \frac{1}{2}"W$ OD

PN208 Small Fill-in Sheet for Fan Panel: $26"H \times 4 \frac{1}{2}"W$ OD

A Field Verification Plate and a Blanking Plate are available for insertion in the holes of the Modular Door Panel, to run a verification of the calibration of the system and cover any non-needed holes in Fan Panels. See details in Appendix C.

A Weather Strip replacement kit is also available.

2.2.1. Modular Door Panel Instructions

For detailed instructions on installing the Modular Door Panel, see the *Modular Door Panel Quick Guide*.

To install the Modular Door Panels

1. Unpack the panels. The Fan Panel is installed first. Place it in the doorway, touching the ground. All panels should expand towards the door hinges. The panels can be expanded by pulling the yellow cords tight, and then securing the cord on the cleat. Do not secure the yellow cords on the Velcro, to hold the straps tight. The Velcro is only meant to hold the straps against the panels. Attach the fan strap.
2. Attach a Fan Panel fill sheet to cover any gap that is created by expanding the Fan Panel.
3. Install the Large-X panel, so that it is touching the top of the door frame. Expand it so that it is held in place securely.
4. If required, install a Small-X panel just below the Large-X panel.
5. Install the XY panel. Expand it both vertically and horizontally to completely seal the doorway.
6. Grill mask can be used to seal any small gaps that remain.
7. A second Fan Panel can be substituted for the Large-X panel if required. However, it should be placed directly above the first Fan Panel, with the Small-X or XY panel being used at the top of the doorway instead.



Figure 14: Modular door panel set installed.

1. Determine which direction of airflow is required and align the fan according to the airflow indicator on the top Fan Panel. Airflow into an enclosure pressurizes the enclosure, and airflow out of an enclosure depressurizes.
2. Insert the bottom of the fan into the Fan Panel.
3. Align the notches on the fan with the corresponding notches on the Fan Panel.
4. Push the fan into the hole, and rotate the fan slightly to secure it in the panel.
5. Hook the fan strap over the edge of the fan shell to hold it in place.
6. Double-check that the fan airflow is in the correct direction. It will be much harder to switch the fan around once all of the equipment has been connected.

2.2.2. Compensating for Panel Leakage

Modular Panels are designed to be placed into doors that are not well sealed. The panel leakage for the Modular Panel is about 14 square inches compared to about 3 square inches for the Aluminum Frame and Cloth and around 1 square inch of leakage for the upgraded Aluminum Frame with snap together corners. These three panels represent three typical doorways: a) Poorly weather-stripped which would have an approximate 1/16 inch gap which equals about 14 square inches leakage; b) A well weather-stripped and adjusted door would be around 3 square inches or leakage; c) A super tight door could be as tight as 1 square inch of leakage and can even have less.

One rule of thumb is that all standards require the blower door panel to be leakier and never tighter than the existing door. The Modular Panel qualifies here. It is likely that the Aluminum Frame and Cloth are tighter than the existing door. In either case, if the door panel leakage is 10% of the total, then further investigation is needed. Panel leakage will vary from one installation to another as will the door leakage.

If you want to make an adjustment to a test result, make these measurements at your reference pressure.

Install the panel in a doorway where the door can be closed with the door fan panel in place, then measure the leakage. This is the Test Panel Leakage + Door Leakage.

Now, tape over the door so it does not leak at all and re-measure the leakage. This is the Test Panel Leakage.

Subtract 2 from 1. This is the Door Leakage.

Subtract #2 and add #3 to your test result.

Modular Panels:

1000 CFM at 50 Pa, no attention needs to be paid to the door panel leakage. If the flow rate is under that you might want to measure the panel tightness compared to the door tightness and subtract any excess from the readings. Or, if the panel is tighter than the door, you will have to add it.

Example; 500 CFM at 50 Pa for the enclosure. Door is closed over top of the panel with the red tube in the gap and leakage measured at 50 Pa of 140 CFM. The door is then taped shut to measure panel leakage which is 80 CFM at 50 Pa. The Door thus leaks $140-80=60$ CFM. Correction to test result is then: $500-80+60= 480$ CFM.

Aluminum Frame and Cloth:

220 CFM at 50 Pa, no attention needs to be paid to the door panel leakage.

Aluminum Frame with upgraded snap together corners and Cloth:

70 CFM at 50 Pa, no attention needs to be paid to the door panel leakage. If the flow rate is under that you should measure the panel tightness compared to the door tightness and subtract any excess from the readings. Or, if the panel is tighter than the door, you will have to add it which is more common and shown in the following example:

Example: 50 CFM at 50 Pa for the enclosure. Door is closed over top of the panel with the red tube in the gap and leakage measured at 50 Pa of 8 CFM. The door is then taped shut to measure panel leakage which is 3 CFM at 50 Pa. The Door then leaks $8-3= 5$ CFM. Correction to test result is thus: $50-3+5= 52$ CFM.

These tests are rarely done but testers should learn how leaky their panels are in advance of any test they may do. Retrotec has performed this test in nuclear power plants where every part of the test needed to be documented including panel leaks. Learning how much your panels leak will be a useful tool to determine how they might be affecting your results. For example, when Modular Panels are used to measure flows well in excess of 2000 CFM, the panel leakage is irrelevant, but in tight rooms it could make the difference between pass or fail. One has to determine then if the door leakage may be a major part of the total and cannot just be deducted. Similarly, if you are using the new tight Aluminum Frame with square snap together corners, your readings might be low.

2.3 Stacking Panels for multiple fan tests

Install any number of fans in any opening with our new stacking panels. Carry them to the test site in a stack that is 30x30" and as high as needed for any number of fans. Get a lot more panels in a small space making shipping faster, cheaper and easier. Just clamp a wood frame into any size of opening. Then screw the Stacking Panels onto the frame and you can snap in any number of Model 1000, 5000 6000, or 7000 Fans. Stacking Panels can be [purchased individually](#) or [purchased as a system](#).

2.3.1. Using the Stacking Panels

- Read and experiment with each step
- To perform multiple fan tests*, refer to:
 - Manual-Blower Door-Multiple Fan Operation 5000 6000 7000
 - FanTestic Software Manual
 - DM32 Operator's Manual

*Tests for CGSB 149, LEED, ASTM E778, EN13829, and ATTMA TS-1 may require more elaborate steps and training. This guide is intended only for familiarization with the controls.

For the latest Retrotec documentation, visit us at: <http://www.retrotec.com/>



Step 1: Prepare the building

- 1.1 Close the outside doors and windows.
- 1.2 Open all interior doors leading to conditioned spaces.
- 1.3 Shut off HVAC, exhaust fans, dryers, A/C, and furnaces.
- 1.4 Turn gas hot waters to pilot.

Step 2: Setup the DM32X's or DM32's

- 2.1 Setup the gauges as needed for the required testing standards.
See: See the DM32X QuickGuide or DM32 QuickGuide
- 2.2 Ensure that rechargeable batteries are fully charged or that spare batteries are available for each gauge.

Step 3: Unpack the Stacking Panels

- 3.1 Remove however many panels will be used for the test.



Step 4: Build a frame

4.1 Prepare a frame out of dimensional lumber to hold the stacking panels.

4.2 Use the Stacking Panels to guide the build design.



Step 5: Secure Panels

- 5.1 Screw the Stacking Panels into the frame.



Step 6: Secure frame to the building opening



6.1 Tightly secure the frame to the building opening. The frame must be stable & reinforced to ensure the structure can maintain force of the fans.

Step 7: Install the fans

7.1 Insert all fans into the Stacking Panels.



7.2 Fasten the metal hook to the Stacking Panel, then wrap the Velcro strap around the fan handle.



Step 8: Seal any remaining gaps

8.1 Excess holes/gaps may exist depending on size of the building opening. Seal all remaining openings.

In the photo below, 9 fans were used and plywood was used to seal the remaining space.

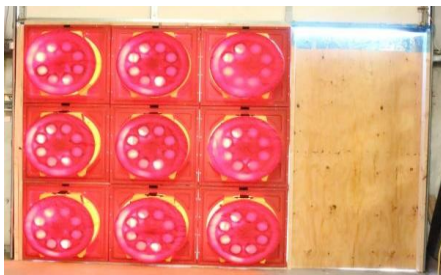

Step 9:

Connect the fan umbilical

9.1 Connect each fan to one of the variable speed drives with the umbilical that is attached to the drive.

9.2 Connect the grey Output cable from the drive to the input port on the fan top.

9.3 Connect the yellow pressure tube to the two ports on the fan top.

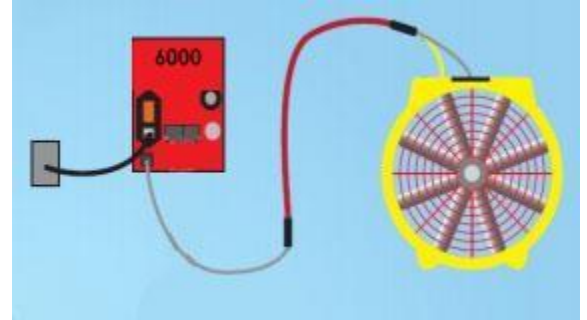

Step 10: Connect all gauges

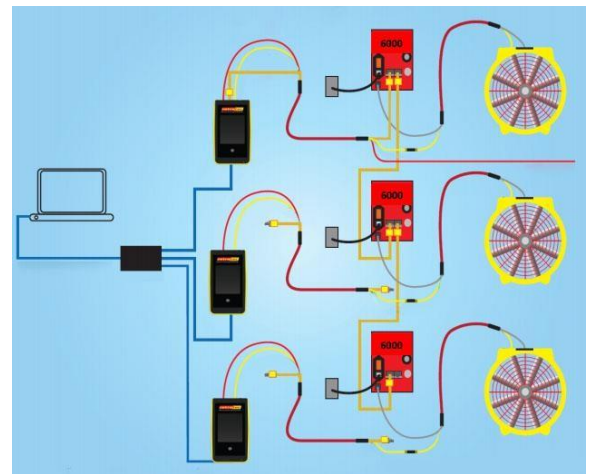

The Triple-Fan Molded Panel Set is a specially designed folding panel which supports up to three 3000 Retrotec fans in one doorway. The panel is included with the QMG system, or can be ordered separately. Blanking plates are included with the Molded Panel Set, so that it can be used with fewer than three fans if required.

2.4 Installing panels in double doorways

To install the Aluminum Frame or Hard Panel in a double doorway, follow these steps:

Secure one of the doors in the closed position using the door closures that push pins below and above the door. Run tape around the top of the door face to the opposite side and then up to the door frame on both sides. Run tape around the bottom of the door face onto the floor on both sides. At the bottom of the door, drive solid door wedges in from both sides. All this is to ensure the closed door does not open when the door panel is installed.

Tape strips on the closed door to act as a temporary door stop and to prevent the panel from sliding away from the stationary door.

Install the Door Panel in the open doorway. Test the Frame's stability by pushing and pulling on the frame to ensure it's secure before mounting the fans. Retighten the expansion mechanism as needed for maximum grip.

As added security, install a strap or line from the fan to the top of the doorway just in case the frame falls out to prevent damage to the upper fan(s).

3. Conduct a Test

3.1 Observe house to avoid problems during testing

3.1.1. Ashes and other materials can blow into house

Depressurizing a house causes air to be sucked in from openings. This can be especially troublesome in a fireplace. If proper care isn't taken to cover exposed, loose ashes, prior to beginning a test, the air flowing in through the chimney can blow ashes out of the fireplace.

Likewise, other loose household materials can be moved around by airflow, especially if the materials are located close to a major leak or the fan itself. It's very easy to blow loose papers, and other small objects around a house if due care isn't taken to secure them before beginning testing.

3.1.2. Doors can slam shut

If a door suddenly shuts while using a Door Fan, the sudden change in pressure can be enough to damage an enclosure or pop the fan out of the panel. Be sure to secure doors in the correct position, prior to starting the fan. If a door shuts during testing, and it goes unnoticed, the accuracy of the test will be affected, because not all of the building will be included in the test, as the area behind the closed door is treated as unconditioned space.

3.2 Select a Location

The first step in any test is to select a doorway, and install the Door Panel.

An exterior doorway in a large open room is best. Avoid doorways that have walls, stairs, or other obstructions nearby. These will restrict airflow, and can lead to inaccurate results.

If the exterior doorway opens to an enclosed porch, garage or other area, open doors or windows to ensure the enclosed area is open to the outside.

3.3 Where to place the exterior Pressure pickup tube(s)

The exterior pressure reference for the differential pressure measurement across the door panel is provided by the red tube. The exterior pickup location must be chosen to minimize the influence of wind, sun and atmospheric pressure on the differential measurement, or measurements must be taken to allow correction for these influences. Each standard defines what is expected in terms of the exterior reference pressure measurement. Use Table 2 to determine where best to locate your red tube depending on the standard procedure you are following.

Table 2: Locations for Exterior Reference Pressure Pickup as required by the various Standard Procedures

Exterior pressure pick-up locations from Standards	
ASTM	1 tube across the middle of each façade (NOT at corners of the building)
	Manifold and average all pressure readings using a manifold (averaged ver 10s)
	If > 3 stories, measured at more than 1 height
ATTMA	Measured at the lowest floor level of the building

	Located "some distance away" from the building envelope, out of the way of fan airflow and sheltered from wind
CGSB	Calm conditions - 1 pressure measurement outside the building is ok
	Windy - min of 4 measurements on each façade, manifold
	Gusty winds - use wind damping kit (capillary tubes, averaged over 5s)
EN13829-FR	Measure at the bottom floor level, but if tall building, measure at the top as well
	Keep exterior pressure taps out of the sun, and fitted to a T-pipe or connected to a perforated box to protect from wind
USACE	Min 1 exterior pressure tap required, but if bias pressures high, use more
	Interior pressure gauge references tied together in a manifold to read 1 pressure reading

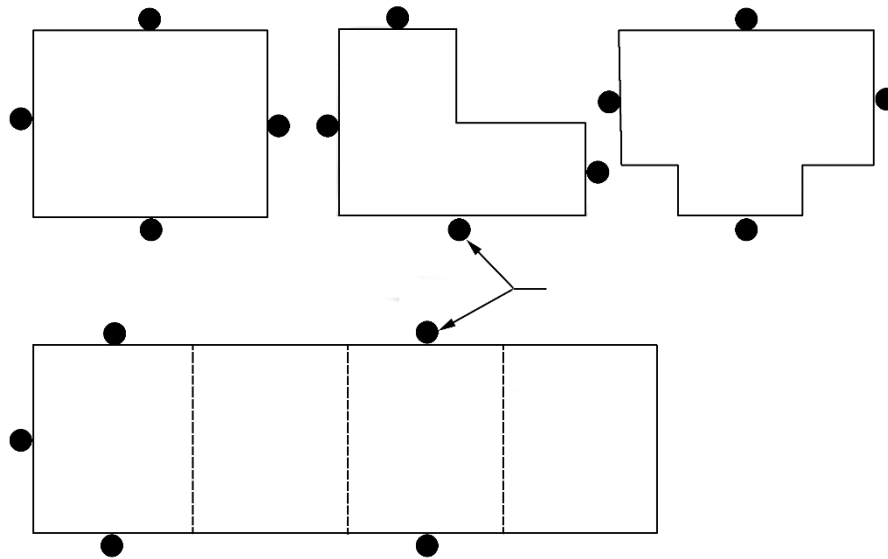

Figure 15 typically recommended locations for exterior pressure pickups

Even though most standards recommend pressure pickup placement as shown above, this is seldom done because the fluctuations are not large enough to warrant the time. In fact, results may be improved by multiple pickups or in some cases may be made worse. Sometimes one exterior pickup is sufficient.

See section 5.8 “**Enclosure pressure measurement disturbances**” for more details on how to avoid pressure fluctuations.

3.4 Determine if corrections for temperature difference are required

In conditions where the interior and exterior temperature differential varies greatly, the fan measurements can be less accurate. In a depressurization test, the Door Fan system measures the

fan flow out of the building. However, the measurement is meant to reflect the air infiltrating into the house through all the leaks. When there is a temperature difference, the air density changes, and the leaks will not exactly equal the measured fan flow. In extreme conditions, this difference can be as much as 10%.

Each Standard that users comply with will require different corrections. FanTestic software will manage these corrections when calculating results after you enter the data.

3.5 Install the Door Fan for Depressurization test

A building depressurization test (blowing air out of the building) is the most common way of conducting a Door Fan measurement. This direction of testing has a number of advantages, but the primary reason is that back-draft dampers in exhaust fans and dryers are pulled closed during depressurization. Since these dampers are usually shut, leakage from them can be left out of calculations resulting from a typical Door Fan test.

The building's door frame can be used to help secure the fan and panel in place. For a depressurization test, install the Door Panel on the inside of the door, the door frame will then help keep the panel in place when the negative pressure tries to pull it through the door way.

To install the Door Fan

1. Install the Door Panel by following either the cloth or modular panel setup instructions.
1. Run the red pressure tube through the hole in the Door Panel to the outdoors. Make sure the end of the tube is not in the path of the fan's airflow.
2. Install the fan in the Door Panel. Make sure the flow direction is out of the building.
3. Connect the digital gauge to the fan. Tubing for a Retrotec DM-2 is connected the same way for both pressurization and depressurization.
4. Connect the fan to a suitable wall outlet for power.

3.6 Set up the Gauge for the Appropriate Test

Refer to the Quick Guide or Manual for the DM32 or DM32X.

3.7 Connect a Fan to the gauge (DM32X/DM32)

It's very simple to connect a Retrotec fan to the Retrotec digital gauges. Depending on which model fan is in use, there will be some combination of red, blue, green, and yellow pressure tubes included. These tubes connect to their corresponding color coded ports on the back of the Retrotec gauge. The Speed Control Cable connects to the port marked "Speed Control" on the port marked "Control" on the top of gauge.

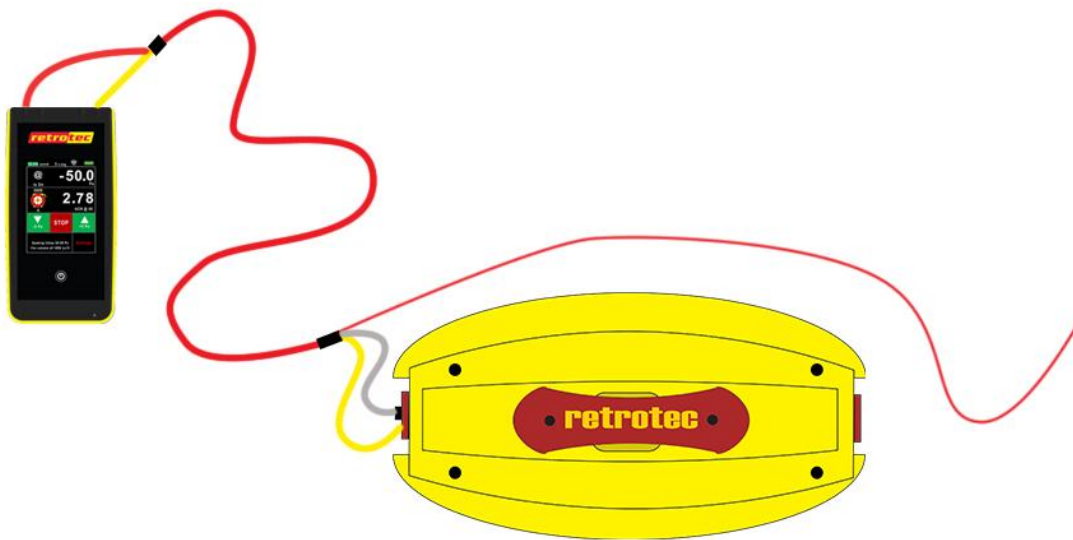

Figure 16: gauge to fan connection.

To connect the fan to a digital gauge

1. All Retrotec fans include a yellow “Ref B” port. Connect the yellow pressure tube from “Ref B” on the fan to the yellow port on the gauge, “Ref B (-)”.
1. For most Door Fan tests, a red pressure tube is run through the Door Panel (away from the tester). The other end of the red pressure tube should be connected to the red pressure port on the gauge.
2. Some model fans will include a self-referencing port (green). Connect the green tube from the port marked “B” on the fan (usually green), to the green port on the gauge.
3. If available, a blue pressure tube can be connected to the blue port on the gauge, for some types of testing.

The green reference port is available on self-referencing fans (Model 300). When this port is present on the fan, connect a green tube from the green port on the Fan Top to the green port on the gauge. The green tube connection will ensure that results are accurate, regardless of the direction of the fan's airflow. A Self-Referencing fan is not affected by airflow that is directed towards the operator, whereas non-self-referenced fans are affected.

When the airflow is directed towards the operator, non-self-referenced fans need to have Fan Pressure measurements corrected for back pressure before air flow results can be calculated. Ensure that the correct Device is chosen on the gauge so the gauge can determine if a correction needs to be applied.

Reference the specific test procedure for more information on which connections need to be made to set up for specific tests.

To control the fan speed with a DM32X/DM32

1. Connect the included Speed Control Cable from the Fan Top to the control port on the top of the gauge. If the original yellow Speed Control Cable provided by Retrotec is unavailable, any standard CAT5, Ethernet-style cable can be used, but users may experience interference between the fan and the gauge.
1. Additional Speed Control Cables can be used to link multiple fans together, with the primary fan being connected to the gauge. This will allow one gauge to control the fan speed of all fans in a chain.
2. If the battery power is too low, charge the gauge with the power adapter provided. The DM32X/DM32 must be powered from an adapter in the wall or into fantop port if available; charging the gauge on a computer may not provide sufficient power.

3.8 Select the correct Range configuration

All Retrotec fans have multiple Range configurations. The Range configurations are used to affect the airflow and fan pressure through the fan. During testing, it is necessary to select the correct Range Configuration to achieve measurable and accurate results.

Each Retrotec DucTester includes five standard Range Configurations and has three optional ranges. Each Door Fan comes with nine standard Range Configurations for the greatest possible accuracy and versatility.

Selecting a Range configuration is based upon the air flow that is required to achieve the test pressure in the enclosure. A general rule of thumb is to select a Range configuration so that the Fan Pressure is twice (or more) the desired test pressure in the enclosure.

Testing should always be done with the most restrictive Range Configuration on the fan as possible for the following reasons:

1. Accuracy increases as Fan Pressure increases
2. High Fan Pressure results in high fan speed, which aids in cooling the fan
3. When conducting multi-point tests, starting with a restrictive Range Configuration eliminates the need to change the Range Configuration during the test.

Note: In European countries where a 50 Hz power system is used, Range Configuration selection becomes more critical because the fans will run 20% slower. Therefore, there is not as much difference between minimum and maximum flow on any given Range Configuration.

3.9 Determine which Range to use on a Door Fan

1. Attach Range Ring A and B. If Ring A contains 4 Pins, ensure they are aligned & inserted.
2. Set the gauge to Range Configuration B
3. Adjust the fan speed until the desired Room Pressure is reached.



If Large Plate contains 4 pins, ensure they are aligned & inserted.

4. If “-” is shown on Channel B of the gauge, attach the B8 Range Plate. Restrict the flow further, until the gauge is able to measure a pressure.
5. Press **Fan Icon** and select the correct Range Configuration icon displayed on the gauge screen.

Or

4. If the desired Room Pressure cannot be reached, take Range Plates or Range Rings off.
5. Press fan icon and select the correct Range Configuration displayed on the gauge screen.

If using analog gauges:

4. Select a Range Configuration so that the Fan Pressure is twice (or more) the Room Pressure.

3.10 Cannot reach required pressure?

If the enclosure to be measured has an excessive amount of leakage, to the point where a single fan unit on the Open Range and at maximum speed, cannot reach the required pressure, try one of the following solutions:

1. Use a second (additional) fan to produce more flow. The combined flow readings can be used to get the total amount of airflow required to achieve the induced pressure. Do not add Fan Pressure readings (PrB), they are not cumulative. Fan Pressure must be converted to flow in CFM (or some other units) and then the resulting flows can be added together.
2. Test at the highest pressure that can be reached, and use the “@” button (only appears when Set Pressure function is engaged) to extrapolate what the flow would be at the desired pressure. Check that the Standard you have to comply will allow this.
3. Seal leaks prior to testing. This can include ensuring that all dampers, windows, and doors are closed, in addition to sealing leaks and holes. This may reduce the leakage enough that the desired test pressure can be reached.

3.11 Choose either a Single or Multi- Point Test Procedure

There are two common Door Fan test procedures available for testing the air leakage of a building: a single-point test, and a multi-point test.

A single-point test establishes a single induced test pressure (typically 50 Pa) in the building; results come from measuring the fan flow required to maintain the pressure imbalance. This is a quick and simple way of measuring airtightness, and by using the Fan Pressure measurement, simple results such as the size of the total leakage can be determined.

A multi-point test requires that the user collect flow data for several different induced target pressure points.

3.12 Taking Manual Single Point Readings

This section is written for circumstances where results are read directly from the gauge.

3.12.1. Measure the Baseline Pressure before turning the fan on

Commonly, test procedures require that the pre-existing pressure across the building be measured and that value be subtracted from the test pressure to uncover how much change occurred in the building pressure due to Test Fan operation. Baseline is sometimes called Bias Pressure or even Static Pressure but we will primarily use “Baseline” here.

The length of time to take the Baseline varies from Standard to Standard or the amount of time needed may not be mentioned. Ten seconds is a reasonable amount of time to spend on Baseline Capture on a calm day but as the wind increases or the Baseline fluctuates at all, this should be increased. To determine the effects of wind, set your gauge to 1 second averaging and if the pressure fluctuation is above 1 Pa, take the Baseline for 30 seconds. If the pressure fluctuation is above 2 Pa, take the Baseline for 120 seconds. If the fluctuation is still above 1 Pa after 120 seconds, continue to acquire the Baseline until the average fluctuates less than 1 Pa.

Save this Baseline once you are satisfied with it. The value stored and displayed on your gauge will be deducted from all future readings so make sure you eliminate the stored Baseline before running your gauge in another application.

3.12.2. Adjust your test fan manually

Adjust the Blower Door (also called Test Fan or Door Fan) fan speed manually using the control knob to the required test pressure that will often be 50 Pa. Change the Range if you cannot achieve the test pressure or if no flow reading appears on Channel B. With the gauge still set to a Time Averaging of 1 second, you may take a reading but chances are you’ll be over or under the required test pressure or the result will fluctuate on either side. To get the exact reading at your test pressure, enter Set Pressure, 50 Pa for example, then press the “@” Key to get results at exactly 50 Pa.

To get an even more accurate result and with the fan still running set the Time Averaging to the same amount of time taken to Capture the Baseline. Channel B will stay blank while the average is being taken after which the result will be displayed. If the fan does not continue to run during this step, and the longer Time Averaging is set, then you must wait until the fan comes up to speed, then wait the time for the Averaging before taking a reading because the gauge will be averaging for the entire time and will be averaging in values below the test pressure. As a rule of thumb, always wait double the Time Average setting before taking readings.

On the DM32, tap Channel A to activate the Hold feature so the readings don’t change while you’re writing them down. On the DM32X, simply tap the “Hold” button.

3.12.3. Adjust your test fan using Set Pressure

Warning: using this automated procedure will allow the fan to run up to full speed should a door or window be opened during the test, causing damage when it is closed. If in doubt, use the previous method.

With the gauge still set to a Time Averaging of 1 second, enter Set Pressure, 50 Pa for example. Change the Range if you cannot achieve the test pressure or if no flow reading appears on Channel B. Once you get within 10% of your desired test pressure, press the “@” Key to get results at exactly 50 Pa and with the fan still running set the Time Averaging to the same amount of time taken to Capture the Baseline. The display will go blank for that same time period after which you can read your result off the display and change units without affecting the readings. You can also HOLD the display, shut the fan down and change units.

3.13 Taking Manual Multi-Point Readings for FanTestic Software

In general, the multi-point test requires that the user collect pressures for a pre-test baseline, collect flows for a set of target pressures (in one or both pressurize and depressurize directions), and sometimes to collect pressures afterwards for a post-test baseline. The collected data is entered into software such as FanTestic in order to generate results from the test which indicate the amount of leakage in the tested enclosure.

Each Standard that users comply with for collecting the data and generating the results have different sets of target pressures (based on different required maximum and minimum target pressures and number of different targets), different requirements for the baseline measurements, and different ways of calculating the results.

The method described in this section is recommended to achieve the most accurate and repeatable test results. Skipping or reducing any of the steps may allow your test results to pass, but this does not mean that an accurate test has been performed.

In order to produce the most Retrotec has included factory defaults in FanTestic which recommend the number or baseline and target points for each of its supported standards. Unless these recommendations are followed, tests will not be repeatable and there will not be enough data to determine what went wrong with a particular test. Retrotec will not be able to analyze the test and recommend corrections if these recommendations are not followed.

3.13.1. Decide how many test points to take

Taking an accurate test means that results will be more repeatable. Taking an inaccurate test means that re-tests of the same enclosure may show very different results. Accurate tests results are achieved with more abundant data, taken over a longer time interval. The EN13829 standard, for example, requires only 5 induced target pressure points but this will usually produce non-repeatable results, as the following graphs show.

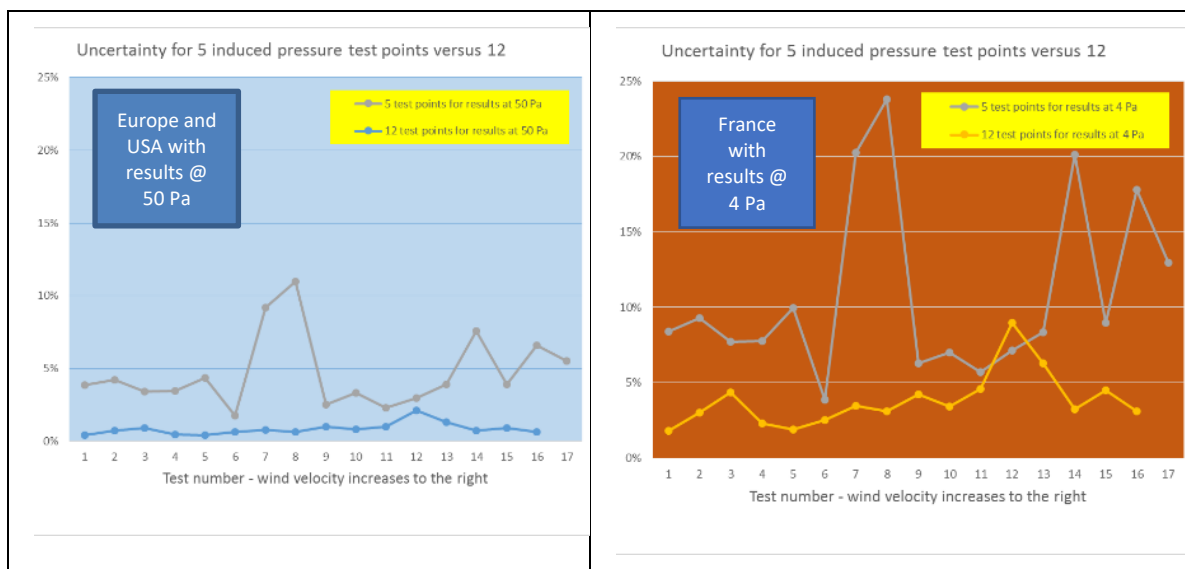

By comparing the average through the 12 point tests (grey line) to that of the 5 point tests (blue line), you can see that taking only 5 test points instead of 12 increases uncertainty by a factor of 5 (~1% vs. ~5%). All 33 tests are identical except for wind conditions. The variation on the 5 point test line is also higher, demonstrating the unreliability of taking tests with fewer data points.

In France the uncertainty variability is more pronounced because results are referenced to 4 Pa instead of 50 Pa. Again, taking only 5 test points instead of 12 increases uncertainty of the 4 Pa results by a factor of 5 (~2% vs. ~10%). Notice also that the uncertainty at 4 Pa is twice as large as that for the results at 50 Pa, reinforcing the importance of taking more data.

3.13.2. Decide whether to test in both directions

Testing in both directions means repeating the set of target pressures: placing the fan to exhaust one direction will cause depressurization and in the other direction will cause pressurization.

By testing in both directions, Uncertainty can be reduced further: usually by 50%. The EN13829 Standard states “It is recommended that two sets of measurements are made, for pressurization and depressurization.” Just like testing with only 5 points, you may get passable results occasionally but if there are problems with your test you may be required to repeat it.

As long as the pressure reference for the gauge remains in the same location during the whole test (inside the enclosure or outside the enclosure), a negative sign on one of the sets of target pressure readings and a positive sign on the other set indicates that the sets were taken in different directions. That location is entered in FanTestic as Operator location. The pressure reference for the gauge is the port that is open (blue port if doing a house test because the red port has a tube connected).

3.13.3. Decide what is the optimum opening size on the fan (Range)

Carrying out this step first is another way to ensure a repeatable test; since uncertainty will be lowest if you can collect data for all target points on a single range. If a single range is not possible, try to arrange that there are at least three points taken on the two ranges that you end up using. It is best not to just rely on the software to advise that you’re on the wrong range or you may end up with up to three ranges in a single data set. Using more than one range can change the Uncertainty by up to 2%. It is fastest to start your test on the correct range so you don’t have to use extra time in the middle of collecting data.

Follow this procedure:

1. Determine the highest test pressure you will require during the test, for example 70 Pa. With the fan blowing away from you to depressurize while you are inside the building, increase fan speed using Set Speed or the control knob so pressure on Channel A rises above 70 Pa but not above 80 Pa. If you cannot reach the desired target pressure (70 Pa in this example), change to a more open range to get more flow. Getting more flow means the open area of the fan inlet must be increased so you are not looking for a higher Fan Pressure but a more open fan. If you can easily achieve 70 Pa, try a less open range that will give less air flow and try again.
2. Determine the lowest test pressure you will require during the test, for example, 15 Pa. Leaving the fan as it was at the end of the previous step, running and achieving the maximum pressure with the most restrictive possible range, decrease fan speed using Set Speed or the control knob so pressure on Channel A falls to just below 15 Pa. There will be times you cannot reach the lowest target pressure (15 Pa in this example). Either you cannot run the fan slowly enough (reach 0% speed before the target pressure reaches 15 Pa), or the flow on Channel B will not show a value (not enough fan pressure is being developed). In either case, you need to change to a more restrictive

range to develop more fan pressure. Since you already determined the smallest range that will let you reach the maximum target pressure (in step 1), you now know that you will have to change range once during your data collection.

3.13.4. Measure the Baseline (Zero Flow) Pressure before the test

Commonly, test procedures require that the pre-existing pressure across the building be measured. That value is subtracted from the test pressure to uncover how much change occurred in the building pressure due to Test Fan operation. Baseline is sometimes called Bias Pressure or Zero Flow Pressure or even Static Pressure but we will primarily use “Baseline” here.

Note that there are two main components of Baseline: one is caused by stack pressures and the other by wind. Stack is a building phenomenon which produces a steady pressure and is simply subtracted from the test pressure. Wind may also cause some steady pressure which can be subtracted. However, wind generally also causes a pressure that fluctuates over time. This fluctuation will distort the induced (applied) pressure difference when the Blower Door is collecting data unless the measurement period is long enough to reduce the effect of the fluctuations.

The length of time the Baseline must be taken varies from Standard to Standard but mostly is not specified exactly which is why this guidance is being provided. EN13829 states “over a period of at least 30 seconds” but does not state the required number of test points.

Recommended procedure to take the pre-test Baseline:

When manually entering data into FanTestic, set the Time Averaging on the gauge to 5 seconds for Baseline readings. Start at 5 second averaging for manual readings since it will take you at least this long to write them down anyway. There is a Baseline feature on the gauge but do not use it for this purpose since it was designed for single point readings.

3.13.5. Measure each of the target points required for the test

Use either the fan speed control knob, the gauge Set Speed control, or the gauge Set Pressure control to capture data for each of the target induced pressure points you need for the test.

When manually entering data into FanTestic, set the time averaging on the gauge to at least 20 seconds for induced pressure and flow readings. This must be done in order to compensate for the effects of wind and to ensure that you get an average reading. On windy days you will have to take readings for a longer period of time. To determine if it is windy, set your gauge to 5 second averaging and check if the pressure fluctuation is above 2 Pa. If so, double the time averaging for the induced pressure and flow readings to 40 seconds.

On the DM32X, tap the HOLD key. On the DM32, you can tap Channel A reading to activate the Hold feature so the readings don't change while you're writing them down. On the DM-2, press the HOLD key. Write down all your readings.

3.13.5.1. Adjust your test fan using Set Speed

All Retrotec fans have a knob for controlling speed. You used this in the earlier check to ensure that the Range installed on the fan is correct and will allow the fan to pressurize to the desired target pressures. You can use the knob or you can use the Set Speed button on the gauge to get to each target pressure.

To take each target pressure point:

1. Adjust fan speed to your highest target point.
2. Activate the Hold feature so the readings don't change while you're writing them down. To activate: On the DM32X, press the HOLD key; on the DM32, tap Channel A; on the DM-2, press the HOLD key.
3. Write down all your readings.
4. Repeat for each required target pressure

3.13.5.2. Adjust your test fan using Set Pressure

You can use the Set Pressure button on the gauge to get to each target pressure. Using set pressure is fastest and most accurate, but heed the following warning.

Warning: *using Set Pressure on the gauge will allow the fan to run up to full speed should a door be opened during the test, possibly causing damage. If in doubt, adjust speeds using the control knob or Set Speed.*

To take each target pressure point:

1. Use Set Pressure on the gauge, and enter the desired target pressure.
2. Observe the flow on Channel B. Change the Range if you cannot achieve the test pressure or if no flow reading appears on Channel B.
3. On the DM32X, press the HOLD key. On the DM32, tap Channel A to activate the Hold feature so the readings don't change while you're writing them down. Press the HOLD key on the DM-2.
5. Write down all your readings.
6. Repeat for each required target pressure

3.13.6. Complete taking the data set for this direction

If your standard requires a post-test baseline, follow the steps as you did in section 3.13.4 when capturing the pre-test baseline.

This will complete a single Data Set for this test. Depending on the direction of fan flow, this data set will be either a Pressurization or a Depressurization Data Set.

3.13.7. Take another data set with fan flow in the other direction

Once the Data Set in the first direction is complete, turn the fan around and start again at section 3.13.4. Collect data until you have taken another pre-test Baseline, another set of target points and a post-test Baseline.

3.13.8. Enter collected data into FanTestic to get Results

Once the test is complete, you will have two Data Sets, each containing a pre-test and post-test Baseline and one will contain target points from the Depressurization data set, and the other will contain a pressurization data set.

Enter this data into FanTestic software which will give you the results you need.

When entering data in FanTestic and testing in both directions, you add data for first direction and then you add a "New Set" and enter data from the second direction. Adding a New Set will produce

a single test file with both the pressurize and depressurize data in it, and FanTestic will automatically combine the results and produce the summarized data as per your selected Standard. Each standard combines the results somewhat differently. Adding a New Set is more efficient than creating a new test file for each set of data, so you can save time.

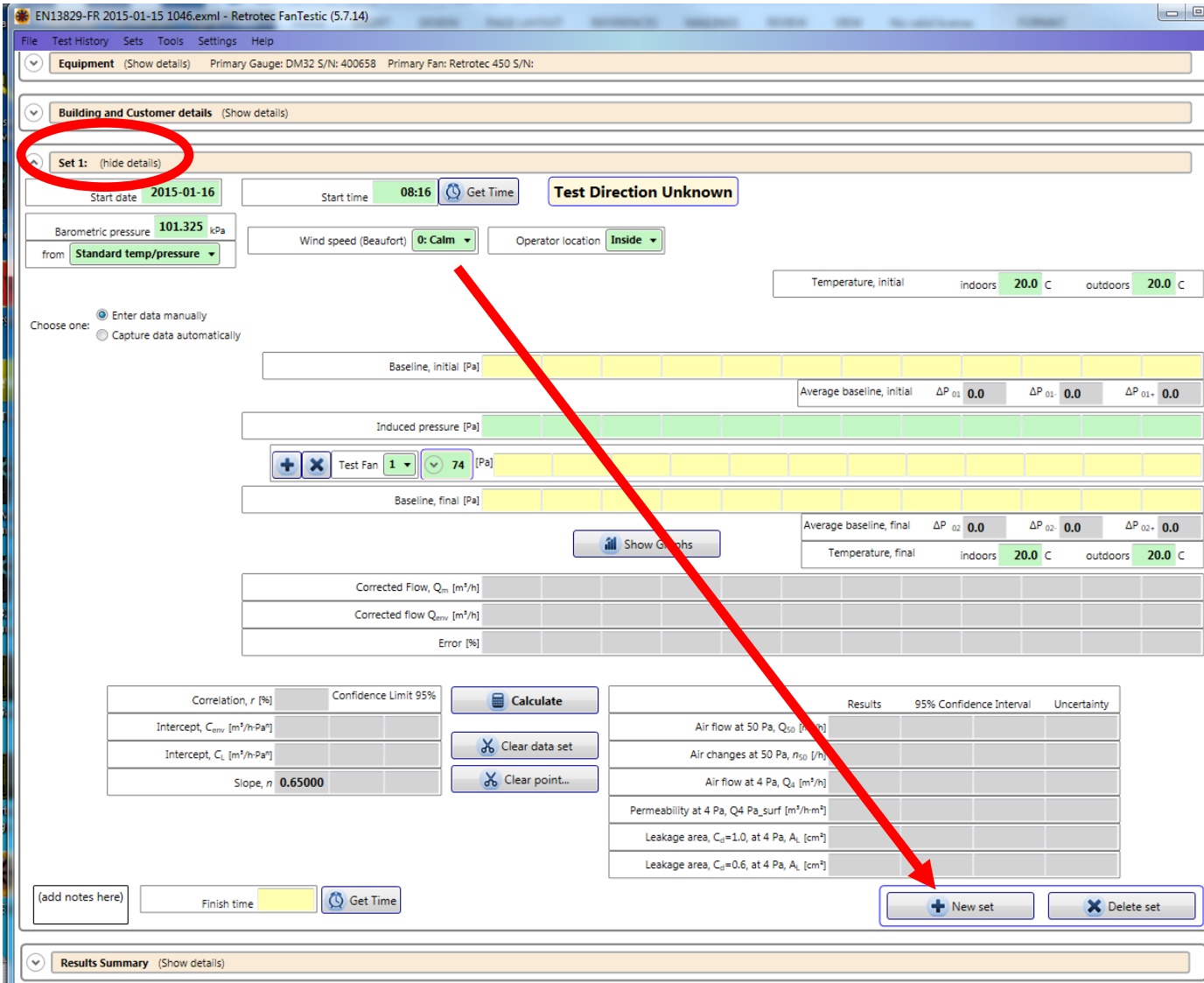

After you add a New Set, there will be two places to add data, one section for each test direction:

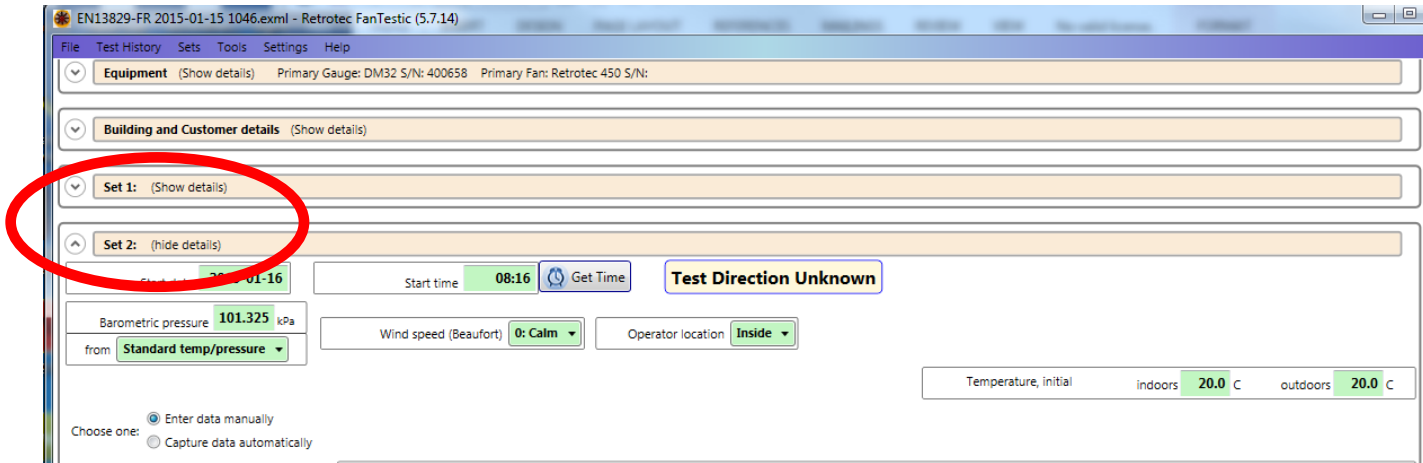

3.14 Completely automated results using FanTestic

You can have FanTestic do all the steps for you but at first, it is wise to follow the preceding manual procedures so you can get a feel for what the software will do for you.

Even if you do use FanTestic to control the test, it is recommended to manually check that the range you have installed on the fan is the optimum one before starting the Automatic test in FanTestic (section 3.13.3).

Ensure FanTestic is set up to test as recommended by Retrotec. Go to the Settings menu, and click “Advanced – view or change default parameters” . In the window that opens, click on “Settings” tab.

Start by clicking on “Reset to Standard Defaults” to be sure your FanTestic has the recommended values. To close this window, use the OK button at the bottom, not the x button in order to be sure your chosen parameters are saved. Only adjust if you have good reason.

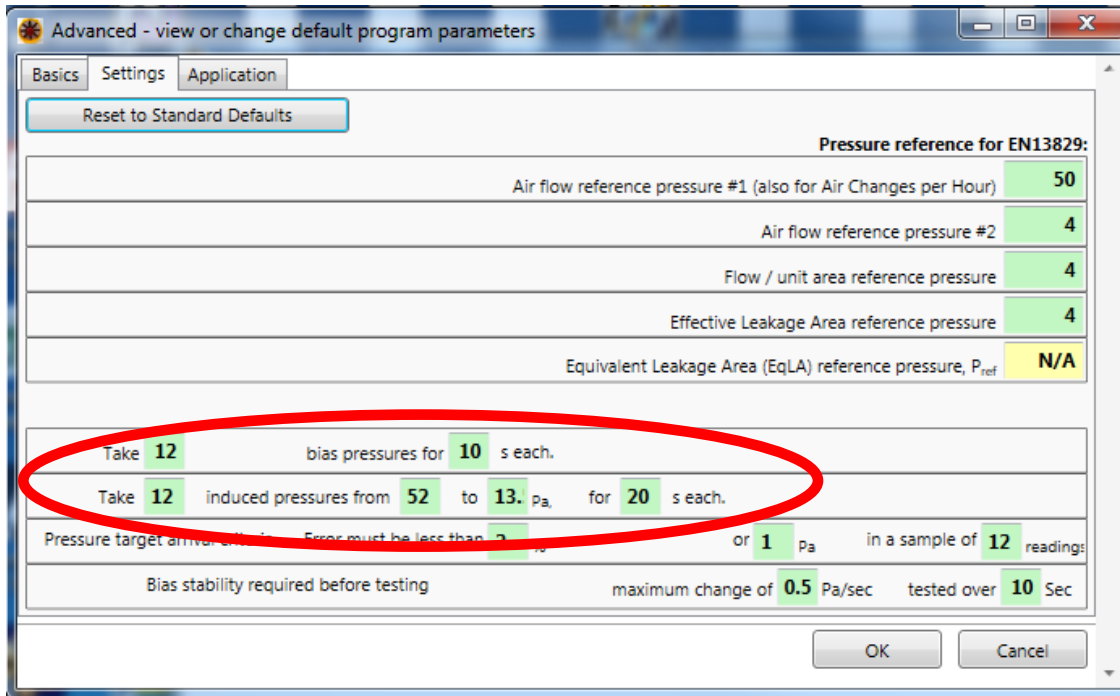

Now FanTestic will run the test for you. Check your FanTestic manual for more details by clicking Help.

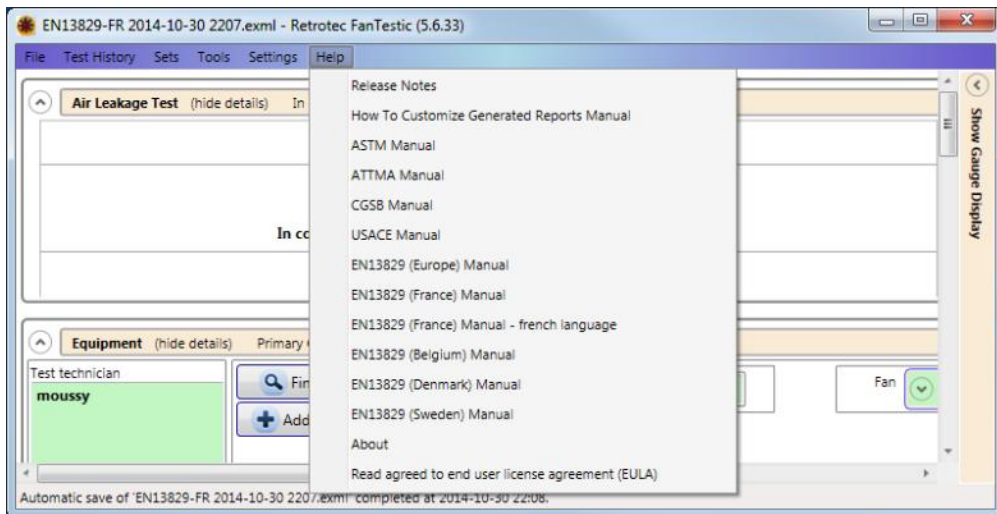

3.15 Basic Results from Single Point Test

Basic test results from a single-point test can be used to provide a simple and quick assessment of a building's airtightness. The DM-2 digital gauge is capable of displaying most common calculations directly on the screen as the measurements are being made.

3.15.1. Air Leakage at 50 Pascal

The industry standard measurement is CFM50. This is the airflow (in cubic feet per minute) required by the Door Fan to create a pressure difference, between the building interior and the outdoors, of

50 Pascals. This difference is roughly equivalent to the pressure that the building experiences in a 20 mph wind.

3.15.2. Air Changes per hour at 50 Pa - ACH50

ACH50 is the number of complete air changes that will occur in one hour, when a building pressure of 50 Pascals is applied across the building envelope. The value is calculated based on the volume of the enclosure, so it is a useful method of normalizing leakage rate.

3.15.3. Equivalent Leakage Area - EqLA 10

Equivalent leakage area is defined as the area of a hole in a thin panel that would leak the same amount of air as the building does at a pressure of 10 Pa with reference to the outdoors. (Discharge coefficient of 0.61)

3.15.4. Effective Leakage Area - EfLA 4

Effective Leakage Area calculation is defined as the area of the elliptical nozzle-shaped hole that would leak the same amount of air as the building does at a pressure of 4 Pa with reference to the outdoors. (Discharge coefficient of 1.0)

3.16 Results from Multi-Point Procedure

Read Retrotec Manuals on FanTestic Software.

4. Avoid Common Sources of Error

Some level of error is unavoidable in all Door Fan testing. However, there are a number of common mistakes that are made that can lead to grossly inaccurate results.

4.1 Wrong Range Configuration or Device

Always make sure that the fan in use, and the Range Configuration that is installed on the fan, is correctly reflected in the settings on the DM-2. Each device, and associated Range Configuration, has a specific calibration. Selecting the incorrect device or Range Configuration will lead to incorrect calculations of airflow and other results.

4.2 No Reference Tube when Pressurizing

When pressurizing an enclosure, the fan is pushing air into the same enclosure in which it is located. It is important to make sure that the fan is referencing the correct pressure.

The DM-2 is capable of self-correcting when the fan flow is towards the fan operator, however, fans with an additional reference port must be connected properly, as the DM-2 will not apply the correction when those devices are selected.

4.3 Incorrect @ Pressure usage

Forgetting that @ Pressure is on can lead to all results being taken at the same pressure. If the flow doesn't appear to be changing when multiple points are being taken at different pressure, check that the @ Pressure function is turned off. Also, if the measurements indicate that the enclosure is far tighter, or leakier than expected, the @ Pressure setting could be converting the results to a vastly different pressure than the desired test pressure.

It is not advisable to use the @ Pressure function when the fan cannot reach a pressure that is even close to the desired pressure reading. This can lead to highly inaccurate results.

4.4 Choose the Appropriate Test Direction

Selecting a test direction is heavily dependent on the type of test being conducted. Consult the specific test procedure to ensure the correct direction is chosen.

All Retrotec fans include an arrow on the Fan Top or control panel to indicate which way the airflow will travel. Use the airflow arrow to determine if the fan is pointed in the correct direction. Buildings often leak exactly the same in both directions but occasionally a small increase in leakage of 5 to 10% may be apparent under pressurization since this test direction can open up flaps over exhaust fans.



Figure 17: Airflow direction arrow on the Fan Top.

4.5 Minimize effects of upstream Air Flow conditions

The calibration for all Door Fans is sensitive to upstream air flow conditions (e.g. orientation of walls, doors, stairs etc..., relative to the fan inlet). This is particularly true when measurements are taken using the Open Range configuration. To minimize problems, follow these rules whenever possible:

1. Install the fan in a doorway leading to a large open room. Avoid installing the fan in a doorway where stairways or other major obstructions to air flow are very close (1-5 feet) to the fan inlet.
2. If the fan must be installed next to a stairway or major obstruction, it is best to take measurements with a Range Ring or Plate installed, and not the Open Range configuration.
3. Open the inside door and outside storm door as much as possible during the Door Fan test to prevent restrictions to air flow.

4.6 Considerations when operating with high backpressure

Note: For most testing applications, backpressure is not a concern and can be ignored.

The term "backpressure" describes the pressure that the Door Fan is working against when it is running. Backpressure is determined by measuring the Baseline pressure difference between the air directly upstream of the fan, and the air directly exiting the fan. Typically, backpressure is simply the test pressure at which the building airtightness measurement is being made (e.g. 50 Pascals). However, in some applications, the Door Fan could experience backpressures that are greater than the test pressure. For example, if the Door Fan is exhausting air into a confined area (such as an attached porch), it is possible that the porch area could become pressurized relative to outside creating a backpressure condition that is greater than the test pressure. Although the Door Fan flow sensor is designed to account for variations in backpressure, certain high-backpressure operating conditions can degrade the calibration of the fan.

Retrotec Door Fans are calibrated to function in testing applications with backpressures up to 80 Pascals, with no significant effect on accuracy. This is true for all Range Configurations, provided that the fan is operated within the accepted Range Configuration. Backpressures above 80 Pa will restrict the available Range Configurations from which accurate results can be obtained. When a Retrotec fan is used, compensation is automatically applied for the backpressure and the flow rate is not displayed when results might be inaccurate.

4.7 Wind effects on test fan accuracy

Measurements are best taken with the test fans in the downwind or leeward part of the building away from velocity pressures caused by the wind. If that cannot be done and if the wind is significant, say above 5 mph, then considerations should be given to the wind effects.

1. When wind strikes a test fan in a blower door system, the accuracy can be affected for the following reasons:
2. Air striking the pressure pickup will alter the fan pressure reading without changing the flow rate
3. The velocity profile across the fan face will alter the relationship between Fan Pressure and flow
4. Turbulence will be added to the incoming airstream

5. A negative pressure may be created as the air passes the fan at a shallow angle.

It has been noted that test fans can read 5 to 20% high when being struck by wind. Experiment with your fan on a wind free day by testing an enclosure, holding fan speed constant and taking a reading. Then, blow air at your fan at different angles and velocities and note any effects.

When this was demonstrated in the classroom this apparatus was used to demonstrate this effect but an enclosure actually works better. In this case the fan blowing into the flex was set to the same approximate flow rate as the fan at the end with a 50 Pa pressure in the duct. The flow rates were compared. The fan at the end was out of the airstream and could be relied upon to create the same flow rate as long as the pressure in the flex was about the same. Then, the fan at the front had air blown at it at about 15 mph using another test fan to determine if there was an effect. Three different fans were mounted at the inlet of the flex. Two had their flow reading increase by 5% while another increased by 20% with the fan at the end of the duct recording the same flow rate as before. This meant that the air blowing at the fans were causing them to read high.



4.8 Enclosure pressure measurement disturbances

Induced enclosure pressures are the difference between outdoors and inside the measured zone. The outdoor pressure pickup point(s) will be affected by wind. Steady winds create pressure that can be subtracted from readings but wind is never steady and it's the fluctuations that cause problems. Generally, on the windward side of the building impacts the ends of pressure tubes creating a positive pressure due to the wind velocity being stopped by the tube. Positive pressures will also result from the overall air movement being stopped by the windward side of the building creating a positive pressure field that can extend 5 to 20 feet from the building. To overcome these effects, it is best to use pickup point(s) away from the direct impact of wind.

The impact of the wind can be best measured by the effect on the gauge. First, extend the exterior pressure pickup point of the tube away from the fan's airstream and about 5 feet from the building. Monitor the gauge for ten minutes. If the gauge reading is above 2 Pa, insert a T in the tube end and cover the tube end with a flat sheet. If still above 2 Pa, T the tube and add two equal length tubes sufficient to be placed in two wind free locations on opposite sides of the building. It may be necessary to T these tubes once more to create 4 pressure pickup points, again with equal length tubes.

Ensure the tube ends are not in contact with water since that will seal them off.

Red tubes are always run through the Door Panel and connected to the Red port on the gauge. If testing from inside the building, red tubes will be run outdoors. If testing from outside the building, a red tube runs through the panel but Blue tubes are used to pick up the outdoor pressure. This is done to ensure, the gauge always reads the pressure in the building with the correct sign, namely, if the building is being depressurized, the gauges will read negative. If pressurized, the gauges will read positive. This works whether the tester and gauges are indoors or outdoors.

Passing more than one tube through the enclosure is possible and an approach that is sometimes used but in general there is seldom an advantage to doing this. As long as the exterior pressure pickup used is in a favorable location, it will adequately represent the outdoor pressure since the outdoor pressure will be unaffected by the test fans since outdoors is an unlimited sink for airflow just like it is when for the grounding of electrical circuits.

Running multiple blue tubes indoors is important because we must ensure all areas in the zone have similar test pressures.

5. Power to run the fan and gauge

5.1 Status lights indicate power and control connections are ready to go

Current Retrotec Door Fans have two LED lights on the Fan Top. “Mains Power” indicates the power status next to the AC power input. The second LED, “Status”, indicates status of the connected gauge.

The 3300(SR) series fan includes a three-phase power supply, which contains two power status lights.

Table 3: 3300SR fans mains power – power input monitoring

3300 Series Fans		
100 – 140 VAC, 22 Amp	210 – 260 VAC, 14 Amp	Indication
Solid green	Off	Low voltage input
Solid green	Solid green	High voltage input
2000 Series Fans		Indication
Solid green		Voltage input

The 3300(SR) fan will operate at a reduced efficiency level when connected to a low voltage input. It is safe to use, but may not reach its maximum operating speed.

Table 4: DM-2 status light indications

DM-2 Status Light	Indicates
Blinking red	Lost communication with DM-2
Solid green	Good communication with DM-2
Flashing green	DM-2 not connected or turned off

5.2 Using the Fan with Mains Power

The 3300 and 3300SR fans are not designed to operate on GFCI protected circuits. Doing so may cause the circuit breaker to trip. Do not operate multiple 3300 or 3300SR fans on the same circuit. Stove top electrical outlets are an ideal 20A circuit to which to connect the 3300(SR) fans.

In European countries where a 50 Hz power system is used the fans will run 20% slower.

5.3 Using the Fan with a power generator

Retrotec recommends a generator with inverter type AC power output. Size the generator capacity above the maximum power required in order to reduce distortion of the AC power waveform. The higher the rated power output, the better. Suggestions for minimum generator output sizes are 3000W for Door Fans and 500W for DucTesters.

Table 5: Acceptable generator power output for specific fans.

Fan	Operating Voltage	Max Operating Current (Watts)	Max Inrush Current	Minimum Generator Power
	120VAC	22A (2640W)	Equal due to soft-start ramp-up of inverter.	3000 W
	208VAC	13A (2704W)		

3300 - 3 Phase Power supply, double wall fan as found in: QMG, Q4E, Q5E	230VAC	10.5A (2415W)		500 W
	240VAC	10.3A (2472W)		
2000 Series , double wall fan as found in Q46, Q56	120VAC	12 (1440W)	15.5A (1860W)	
	208VAC	6.2A (1290W)	7.6A (1580W)	
2350 , double wall fan as found in Q46, Q56	120VAC	10A (1200W)	23A (2760W)	
	208VAC	4.5A (936W)	10A (2080W)	
1000 Wheel rim style, single layer	120VAC	12A (1440W)	23A (2760W)	
	208VAC	4.8A (998W)	11A (2288W)	
DU200 Series DucTester	120VAC	2A (240W)	2.5A (300 W)	
	208VAC	N/A	N/A	
DU200 w/2350 Fan Top	120VAC	2A (240W)	3A (360W)	
	208VAC	0.9A (187W)	1.2A (250W)	

When selecting the generator, look for key words and phrases including:

“inverter output”

“utility-grade AC power”

“suitable for sensitive electronics”

Table 6: Portable generator AC power output types.

Type of AC Power Output	Comments/Expectation	
Inverter	Best; Compatible	Recommended
AVR – Automatic Voltage Regulation	Questionable; May not perform	Not Recommended
Brushless	Worse; May not perform	Not Recommended
CycloConverter	Worst; May not perform	Not Recommended

<h2>5.4 Recommended Generators</h2>	
<p style="text-align: center;">5.4.1. Honda Generator EU2000 (120V, 2000W, 67 lbs)</p> <p>Works with all DucTester fan models. Works with both 2200 and 2350 series fans. The Honda EU2000 provides 2000 watts and 120V AC power. It is equipped with an inverter, and is specially designed for sensitive electronic equipment. At 16.7 Amps, it meets the needs of most Retrotec equipment, although it does fall below the recommended minimum power output.</p>	

<p>5.4.2. GENYX G3000HI (230V, 3000W) generator</p> <p>Works with all Retrotec Fans. The G3000HI is equipped with an inverter, and runs at 230V and a maximum of 3000W. It meets the minimum requirements for even the most powerful Retrotec equipment.</p>	
---	---

--	--

<p>5.5 Portable Power Supplies for DucTester</p> <p>Portable power supplies can provide enough power for Retrotec DucTester fans, but are unlikely to produce sufficient power for a Door Fan. Please ensure that the power supply meets the minimum power requirements of the fan before attempting to use one.</p>	
---	--

<p>5.5.1. Black and Decker Electromate 400 Model VEC026BD</p> <p>Works with DucTester fans with a 2350 Fan Top. Do not use with Door Fans, or with DucTesters without a 2350 Fan Top. The VEC026BD is a 110/120VAC power supply with a built in 400W inverter.</p>	
---	---

6. Maintenance and Field Checks

6.1 Pre-test checks

- Inspect tubes and tube connections for blockages that can occur due to water or dust. The gauge manual has an exact procedure for conducting this check.
- If dust is observed, or the fan has been in an environment high in dust or moisture, use a vacuum cleaner to clear the 4 ports on the fan nacelle of dust and/or water in the places where the tubing attaches to the fan.
- When the fan is plugged into mains power, the LED must light up showing power is getting to the motor. If not check to see if that wall outlet has power.

WARNING: gypsum dust (from sheetrock sanding) will prematurely wear out the bearings and may plug the fan pressure ports, preventing the measurement of pressures and flows.

Retrotec Door Fans maintain their calibration unless physical damage occurs. Conditions which could cause the fan calibration to change are movement of the motor and blades, relative to the fan housing, damaged flow sensors, and leaks in the sensor or tubing running from the flow sensor to the fan pressure tap.

6.2 Check motor and fan blade position

Model 5000, 6000 , 7000 Fans as shown

Fan calibration can change if there has been movement of the motor and blades, relative to the fan housing. Such a damaged condition will be easily apparent if the B8 Range Plate will not sit properly on Range Ring A, or if the motor mount looks bent.

Place a straight edge across the front of the fan. There should be no gap from the straight edge to the decal on the nacelle which is in the center of the fan. If this gap exceeds 1/8 " (3 mm) the Open range will start to be off its spec.



Model 3000 Fans –pre 2016

Place a straight edge across the front of the fan. There should be 1/8 " (3 mm) gap from the straight edge to the decal on the nacelle which is in the center of the fan. If this gap exceeds 1/4 " (6 mm) or is 0, the Open range will start to be off its spec.



Model 1000 or 2000 Fans –pre 2016

Place a straight edge across the front of the fan. There should be 3/16 " (4.5 mm) gap from the straight edge to the decal on the nacelle which is in the center of the fan. If this gap exceeds 5/16 " (7.5 mm) or is less than 1/16 " (0.5 mm), the Open range will start to be off its spec.



Model 300

As long as the impeller does not rub when it turns, clearance will not affect flow measurement.

6.3 Check for Flow Sensor leaks

Retrotec calibrated fans use four flow sensors that are mounted inside the plastic housing that goes over the front of the fan. To test for leaks in the sensor or from the sensor to the fan pressure tap:

1. Attach a piece of tubing to the yellow connector on top of the fan. Leave the other end of the tubing open.
2. Find the four small holes located on the red plastic that covers the motor. They should be evenly spaced around the motor, with one on the top, bottom, left, and right. Temporarily seal the four holes by covering them with Tuck Tape or masking tape.
3. Suck on the open end of the tube, to create a vacuum in the tubing. Cover the end of the tube with your tongue or finger, if the tubing sticks, a vacuum has been created, and the flow sensor does not leak. Make sure that the vacuum persists for at least 5 seconds. If you hear a sound of air moving through the tubing, then there may be a disconnection inside the fan somewhere.
4. Remove the tape from each hole individually, and ensure that air can be sucked through that particular hole. Check each of the four pressure sensing points in turn.



Figure 18: Pressure sensor on the fan motor casing.

Method 2

Leaks can easily be detected by plugging all 4 holes in the nacelle, then simply plug a gauge into the yellow port on the fan-top. The pressure will rise very slowly from the heat of your hand on the tubing. If the pressure does not drop off you have no leaks.

Method 3

Shown for 300 but same method works well for all fans.

If Fans read low, it may be caused by internal disconnections. This can be checked by taping over the eight pressure pickups inside the Fans inlet. Then attach a tube to the Yellow port, T the tube to the gauge, then push the third tube about 1 inch under the water. You should see roughly 100 Pa staying fairly constant. If it drops slowly, that is not a problem but if it falls to zero in a minute or less, there is a leak in the system which will cause the Fan to read low.



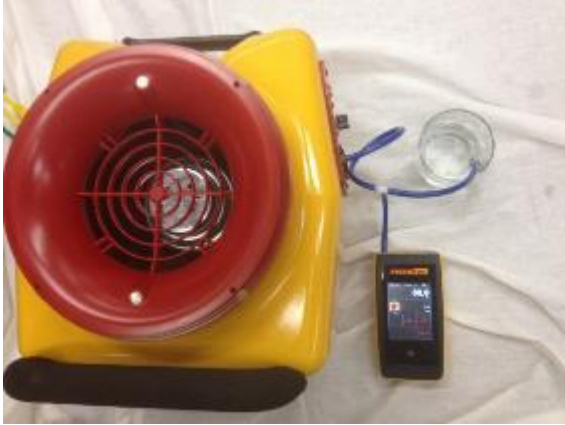

If you perform depressurization tests, you will also have to test the green port. The 4 holes are difficult to seal with tape but wetted round toothpicks, soft wax, play dough, modelling clay or silly putty will seal them well enough to test for leaks. Insert the tube into the Green port and push tube into water again. The round toothpicks work well but to have to be tapped gently into the holes to seal the micro grooves in the wood.

6.4 Check Fan for blockages

If Fans don't give any flow readings at all or fail the Field Calibration Plate test, the tube might be blocked. The Fan would have to be subjected to being completely hosed down to seal all the sensor locations that were sealed off in the previous section but the one Green or Yellow port could have been blocked on its own. If you notice a pressure when the tubes are connected and the fan is not running, that might be caused by blocked tubes.

You can also blow into a tube and listen at each port for air hissing. Or use tiny amounts of soapy water.

6.5 Check maximum flow on Open Range

With fan running full speed in free air on Open Range the Fan Pressure signal from the yellow port should be within 15% as follows:

3000/6000 Fans: **232 Pascals** Voltage of 120 or 240. Lower voltages will produce lower readings.

2000 Fans: **130 Pascals** Voltage of 120 or 240. Lower voltages and 50 Hz will produce lower readings.

1000/5000 Fans: **142 Pascals** Voltage of 120 or 240. Lower voltages and 50 Hz will produce lower readings.

6.6 Checking the fan blade clearance

1000/5000/6000/7000 series fans

Should have 1/8" clearance between each blade to the shell.

2000/3000 series fans

Should have 3/16 – 1/4" clearance between each blade to the shell.

6.7 Perform a field verification monthly

A field verification of the fan calibration should be performed approximately monthly. It is a simple way to verify that the equipment is still operating correctly. Some standards such as RESNET require this to be done yearly and for records to be kept. This “check” is not a calibration of any range in particular but does test the pressure pickups to see if they are leaking or blocked because those are the most common problems with the equipment. If one range is reading correctly, there is a good chance the others are also but this does not take the place of a complete calibration which would test the calibrated fan at the top, middle and bottom of each range and determine the error at each test point. This Complete Calibration is an expensive test to perform because to do it properly requires over \$100,000 in test equipment, (which is why it’s expensive). For many applications testing on one range regularly is the best option. If the equipment is out more than 10 to 15%, the equipment should be sent back to the manufacturer for a complete calibration test.

A field verification check on the gauge described in the DM32X, DM32, and DM-2 Manuals should be done prior to performing this check.

To perform a field calibration using a doorway

1. Install cardboard with a 20 x 20 inch hole in the upper part of a doorway in a room with all exhaust and supply registers sealed. A square hole is easier to cut accurately compared to a round hole but the round is supposed to work better although we have never noticed much difference.
2. Set Time Averaging to 10s and Press the [@] button until “@50.0 Pa” appears.
3. Perform a Door Fan test on the room and record the EqLA at 50 Pa with the hole open and again with it sealed.
4. Subtract the first result from the second result and the value should be 400 sq in (at least +/-10% and sometimes within 5%). This is about 3100 CFM50 and even though EqLA is used the gauge is merely doing the math to display CFM at area.

The same check can be performed with the field Verification Plate, which can be purchased for the Modular Door Panel system.



Figure 19: Homemade verification plate.

6.8 Most common cures

Modern gauges tend to be very reliable as long as the tubes are not blocked or leaking which is easy to check for. While gauge accuracies are typically 1% of reading, blower doors and duct testers are typically around 5% when calibrated in the lab and typically no better than 10% in the field. The

contribution of the gauges to reading errors is very small. A gauge error of 20% will create a flow reading error of only 10% which points to the flow device as the source of errors in most cases.

When looking at large errors, these are the issues to look at first:

1. Water drop in the end of a tube, way over 10% error.
2. Leaking tube, 5 to 10% error common.
3. Pinched tube, no limit to error.
4. Misalignment of the fan, 5% error maximum.

Appendix A: Calculate Airflow Manually

When testing without a computer, or when testing very large or leaky buildings, it may be necessary to calculate the airflow manually.

Note: Manual calculations are really only appropriate for Single Reading Tests. It is possible to do a Multi-Reading Test manually and attempt to plot out the results on log-log graph paper, but it is not recommended.

To calculate airflow

1. Record the Door Fan Range Configuration.
2. Adjust the fan speed to achieve the desired Room Pressure.
3. Record the Fan Pressure (Channel B on the DM-2, lower two gauges on the analog gauge clip).

If using a computer program:

4. Record the indoor and outdoor temperature.
5. Record the airflow direction.
6. Input the induced Room Pressure and the Fan Pressure into the software, and calculate the results.

If calculating manually:

7. When pressurizing (flow towards operator), subtract the Room Pressure from the Fan Pressure to determine the true Fan Pressure.
8. Using the Manual Flow Tables listed in the *DM-2 Operation Manual*, locate the true Fan Pressure in the left column and read the airflow under the appropriate Range Configuration column.

Manually calculated flows may vary from the more accurate computer output for several reasons:

The Fan Pressure is corrected for Room Pressure which is not known so is approximated to equal Fan Pressure.

The computer corrects each input for gauge error.

The computer may add a fan correction factor K4.

In spite of these reasons, manually calculated results will typically be within 2% of the computer result.



When using multiple fans, never add Fan Pressures, they aren't additive. Determine airflows in CFM separately and add the flows together to determine total airflow.









The Manual Flow Tables are listed in the DM32X, DM32, and DM-2 Operation Manuals.

Appendix B: Find correct CFM at particular fan pressure

Use simulator in Virtual Gauge, or the DM32 Flow Calculator.

Appendix B: Find Door Fan System Part Numbers

Fans & Accessories			
Part #	Product	Part #	Product
FN507 110v/50hz, FN508 240v/50hz, FN509 120v/60hz	FN500 	6000 series fan for use with Model 6000 high power drive.	FN600 
7000 series fan for use with Model 7000 high power drive.	FN700 		

<p>FN601 110v/50hz, FN6002 120v/60hz, FN603 240v/50hz</p>	<p>Drive for Model 6000 high power fan</p> 	<p>FN701</p>	<p>Drive for Model 7000 high power fan</p> 
<p>FN211</p>	<p>Hard Sided Fan Case</p> 	<p>Cover for Front or Back of Fan</p>	<p>FN130</p> 
<p>FN500 Ring A for 4000/5000/6000/7000 series fan</p>	<p>FN500</p> 	<p>FN501 B8 Plate for 4000/5000/6000/7000 series fan</p>	<p>FN501</p> 
<p>RP000 Range plug blank</p>		<p>Additional ranges available RP001, RP002, RP003, RP007, RP011, RP018. RP029, RP047, RP074</p>	





--	--	--	--

Regular Aluminum Frame	
Door Panel and Frame Model:	AL250R (2015)
Type of Panel:	Regular Cloth Panel & Frame – Single 1000/3000/5000/6000/7000 Fan
Type of Frame:	Regular Sized Red Anodized Frame (2015)
Width (min/max):	29.5" - 45" (75 - 109 cm)
Height (min/max):	53" - 97" (135 - 246 cm)
Frame Thickness:	1.75" (5.3 cm)
Weight:	16 lbs (7.3 kg)
Window (small) Aluminum Frame	
Door Panel and Frame Model:	AL???R (2015)
Type of Panel:	Regular Cloth Panel & Frame – Single 1000/3000/5000/6000/7000 Fan
Type of Frame:	Regular Sized Red Anodized Frame (2015)
Width (min/max):	18.25" - 27"
Height (min/max):	30.25" - 51"
Frame Thickness:	1.75" (5.3 cm)
Oversize Aluminum Frame	

Door Panel and Frame Model:	AL265
Type of Panel:	Cloth for Large Frame – Double 1000/3000 Fan
Type of Frame:	Large Aluminum Frame (2015)
Width (min/max):	32" - 50" (81 - 127 cm)
Height (min/max):	60" - 109" (152 - 278 cm)
Frame Thickness:	1.75" (5.3 cm)
Weight (approx):	25 lbs (11.4 kg)

Product	Part #	Product	Part #
AL271	Male TRLL 	AL272	Female TRLL 
AL273	Male TLLR 	AL274	Female TLLR 
LS300	Power tiny: LS303 flight case, LS308 Duct Adaptor Hose diameter 32mm, LS140 2L of tiny fluid	AL107	Aluminum Frame Replacement Knob



Cloth Door Panels			
AL251	Standard Door cloth 1000-7000 fans 	AL351	SmartCloth™ Wind Dampening Blower Door Cloth 1000-7000 fans 
AL261	Large Door cloth 1000-7000 fans 	AL256	Double fan cloth for standard 42" frame. 







AL265	<p>Double fan cloth for Large 50" frame</p> 	AL266	<p>Triple fan cloth for large 50" frame</p> 
AL257	<p>Cloth for 200/300 series fan for standard 42" frame</p> 	AL267	<p>Cloth for 200/300 series fan for Large 50" frame</p> 





Modular Door Panels			
PN20 1	Modular Door Panel Set (includes carrying case)	PN206R	Fan Panel

			
<p>PN20 7</p>	<p>Large Fill-in Sheet For Fan Panel (for use when Fan Panel is extended out)</p>	<p>PN208</p>	<p>Small Fill-in Sheet for Fan Panel</p>
			
<p>PN21 0</p>	<p>Large-X Panel</p>	<p>PN211</p>	<p>XY Panel</p>
			

PN209	Small-X Panel	PN213	Field Verification Plate for Modular Door Panel
			
PT112	Weather Strip Repair Kit for Modular Panel (1 panel)	PT110	Weather Strip Repair Kit for Modular Door Panel (4 panels)
	Picture of the weather strip		Picture of the weather strip
PN212	2000/3000 Fan Panel Blanking Plate	PN204	Panel Case with Shoulder Strap
			
PN302	3-Fan Molded Panel Set for 2000/3000 fans (includes 3-Fan Cordura Panel Case)	PN311	3-Fan Molded Panel Cordura Panel Case
			
FN234	Fan Safety Strap for Modular Door Panels (for securing Door Fan onto Door Panel)		
			

Digital Gauges			
DM32X		DM32	
			
DM221	DM-2A Mark II 2-channel Digital Gauge with Automatic Control. Does not work with 300, 5000, 6000, or 7000 fans. Use for Pressure on both channels. This gauge has been discontinued.		
			
System Accessories			
DM235 DM218 DM224 DM241	Umbilical for 1000 fan, 6.5ft (2m) Umbilical for 2000 fan, 20ft (7m) Umbilical for 3300SR fan, 20ft (7m) Multi-fan Umbilical, 75ft (22.5m)	DM222	Optional Umbilical extension for 3300 fans, 75 ft (22.5 m) (includes DM-2 Umbilical Extender box)

			
DM229	DM-2 Umbilical extender (box only)	DM212	USB Cable Type A to Mini B - 6ft (2m) (for connecting DM-2 to computer for automatic fan control and data retrieval using Retrotec FanTestic software)
			
DM205	Control Cable for 1000/2000/3000 Digital Fan - 20ft (7m) Includes green, yellow, red, and blue tubes (37 ft); Static pressure probe, copper tube, T-connector, male-to-male connector)	DM203 (120v or 240v)	9V Country Specific Power Supply DM-2
			
TU119		FX201 Imperia 1 FX202 Metric	1000/2000/3000 Flex Duct (24")
Tubing Accessory Kit			
GR116	Grill mask available in multiple sizes	GR106	Grill Mask Dispensers

			
GR117	Grill mask, case of 4	LS800	Tiny S Mini Fog Generator
			

Appendix C: Optional Door Fan system components

Flex Duct to measure air flow or neutralize pressure drops

Flex Duct is available in two sizes. A 12-foot long, 24-inch diameter Flex Duct is compatible with all Retrotec Door Fans, and can be used to neutralize the pressure difference across a dropped ceiling, below a raised floor, or to measure the air flow through large registers and vents. When using the Flex Duct, it's important to extend it out to its full length in a straight line.



A smaller, 10-inch diameter Flex Duct is included with all Retrotec duct testing systems, and makes it easy to direct the fan airflow into the duct system.

Wind Damping Kits to minimize wind effects

Wind Damping Kits help to minimize the effect of wind on an exterior reference pressure tube. For more information about dealing with problems, see [Troubleshooting](#).



Figure 21: Basic wind-damping kit.



Figure 22: Deluxe "wild wind tamer" wind-damping kit.

Cases and Bags

Sturdy cases or bags are available for all Retrotec equipment. Fan cases can protect your fan from damage during transport, and make it easier to carry on location. Replacement bags are available if needed.

All Retrotec bags are hard sided, and made of a durable nylon weave that is hard to tear and is weather resistant.



Figure 23: Carrying cases for fans.

Using Retrotec Blower Door with QuietCool Whole House Fan Powered Flow Hood

A Retrotec Blower Door system may be used to test whole house fan airflow rates when paired with a QuietCool Whole House Fan Powered Flow Hood Model WHF-PFH and used according to the WHF-PFH manual. When used configured with Open Fan, Ring A, or Ring B, this powered flow hood can be used to measure whole house fan airflow rates from 300 to 5500 CFM with no change to the published accuracy of +/- 3%. This performance meets the accuracy requirements of the California Energy Commission document RA3.9, "Field Verification and Diagnostic Testing of Whole House Fans (WHF)".

Appendix D: Model and System Names

Naming conventions for Blower Door Systems with 22-inch fan shells

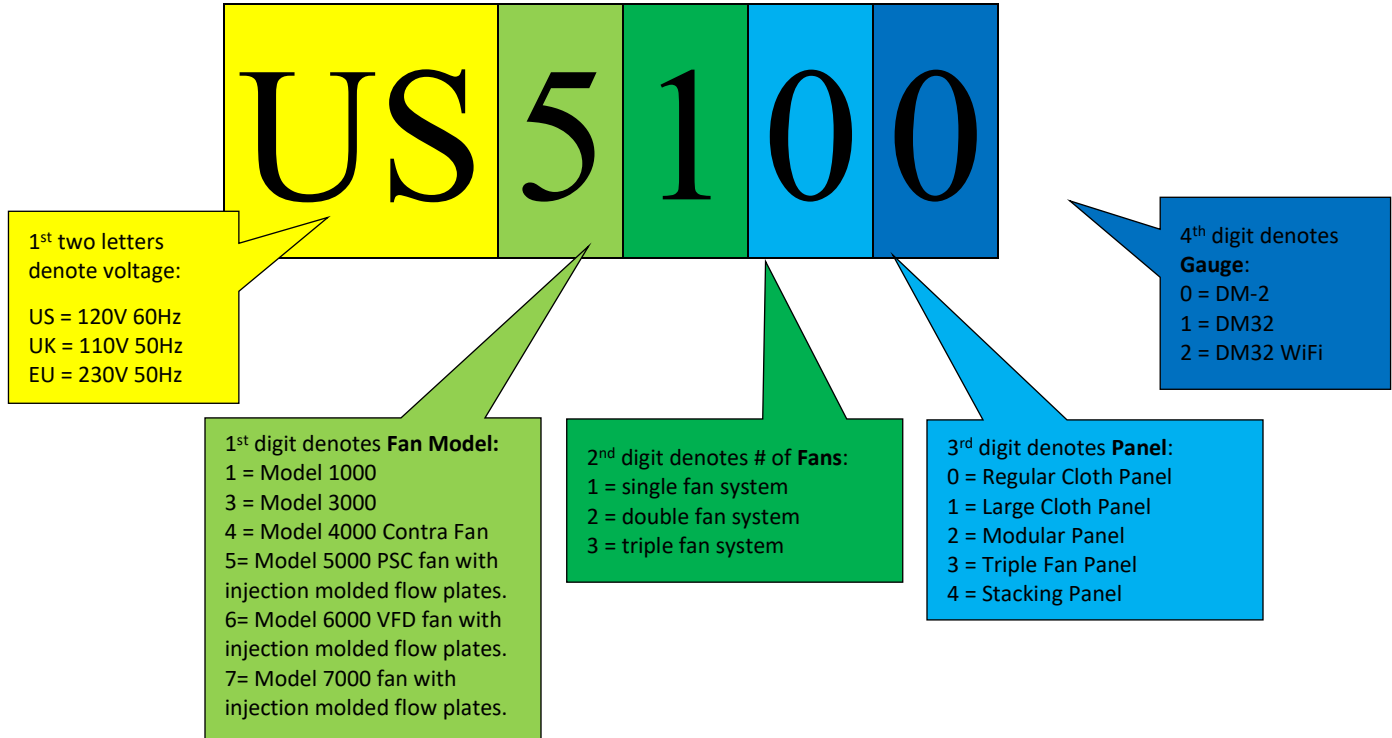

Naming conventions for Systems with 10 inch fan shells

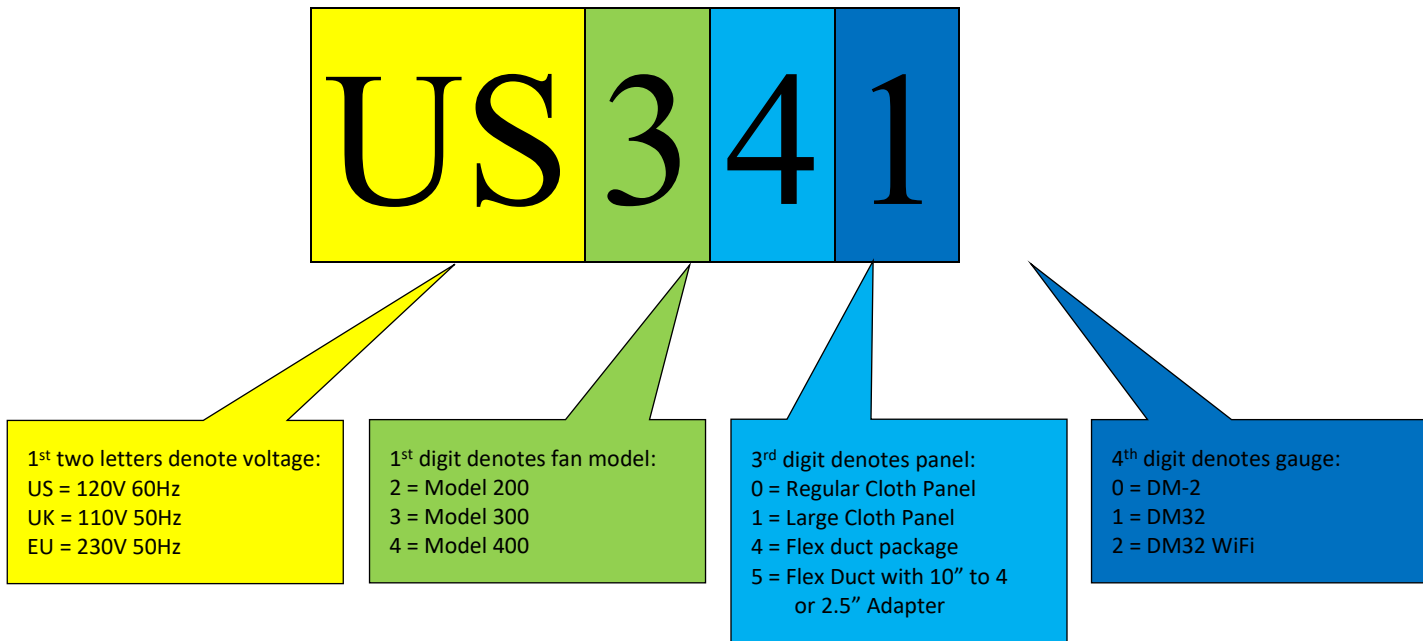

Residential and Commercial Multi Family For: 120V/60Hz, commonly used in North America, System

Prefix = US

Name used prior to 2013-07-15	Model Number With DM2	Model Name With DM2	Model Number with DM32	Model Name with DM32. "1" at the end signifies DM32	Model Number with DM32 Wi-Fi	Model Name with DM32 Wi-Fi, "2" at the end signifies DM32 with WiFi
DU200 DucTester	US240	Model US240 DucTester with DM-2	US241	Model US241 DucTester with DM32	US242	Model US242 DucTester with DM32 WIFI
US200 Blower Door	US200	Model US200 with Cloth Panel and DM-2	US201	Model US201 with Cloth Panel and DM32	US202	Model US202 with Cloth Panel and DM32 WIFI
US210 Blower Door Large Cloth Panel	US210	Model US210 with Large Cloth Panel and DM-2	US211	Model US211 with Large Cloth Panel and DM32	US212	Model US212 with Large Cloth Panel and DM32 WIFI
US1000 Blower Door	US1100	Model US1100 with Cloth Panel and DM-2	US1101	Model US1101 with Cloth Panel and DM32	US1102	Model US1102 with Cloth Panel and DM32 WIFI
New US1000 Large Cloth Panel	US1110	Model US1110 with Large Cloth Panel and DM-2	US1111	Model US1111 with Large Cloth Panel and DM32	US1112	Model US1112 with Large Cloth Panel and DM32 WIFI
New 2 fan US1000 Large Cloth Panel	US1210	Model US1210 Double Fan with Large Cloth Panel and DM-2	US1211	Model US1211 Double Fan with Large Cloth Panel and DM32	US1212	Model US1212 Double Fan with Large Cloth Panel and DM32 WIFI
New 3 Fan US1000 Large Cloth Panel	US1310	Model US1310 Triple Fan with Large Cloth Panel and DM-2	US1311	Model US1311 Triple Fan with Large Cloth Panel and DM32	US1312	Model US1312 Triple Fan with Large Cloth Panel and DM32 WIFI
Q4E	US3100	Model US3100 with Cloth Panel and DM-2	US3101	Model US3101 with Cloth Panel and DM32	US3102	Model US3102 with Cloth Panel and DM32 WIFI
New Q4E Large Cloth Panel	US3110	Model US3110 with Large Cloth Panel and DM-2	US3111	Model US3111 with Large Cloth Panel and DM32	US3112	Model US3112 with Large Cloth Panel and DM32 WIFI
New 2 fan Q4E Large Cloth Panel	US3210	Model US3210 Double Fan with Large Cloth Panel and DM-2	US3211	Model US3211 Double Fan with Large Cloth Panel and DM32	US3212	Model US3212 Double Fan with Large Cloth Panel and DM32 WIFI
New 3 Fan Q4E Large Cloth Panel	US3310	Model US3310 Triple Fan with Large Cloth Panel and DM-2	US3311	Model US3311 Triple Fan with Large Cloth Panel and DM32	US3312	Model US3312 Triple Fan with Large Cloth Panel and DM32 WIFI
Q5E	US3120	Model US3120 with Hard Panel and DM-2	US3121	Model US3121 with Hard Panel and DM32	US3122	Model US3122 with Hard Panel and DM32 WIFI
QMG	US3330	Model US3330 Triple Fan with Folding Panel and DM-2	US3331	Model US3331 Triple Fan with Folding Panel and DM32	US3332	Model US3332 Triple Fan with Folding Panel and DM32 WIFI

New System Large Cloth Panel Contra Fan	US4210	Model US4210 Double Contra Fan with Large Cloth Panel and DM-2	US4211	Model US4211 Double Contra Fan with Large Cloth Panel and DM32	US4212	Model US4212 Double Contra Fan with Large Cloth Panel and DM32 WIFI
---	--------	--	--------	--	--------	---

For: 110V/50Hz, commonly used in the UK, System Prefix = UK **When ordering a 240 V unit for the UK, use EU**

Name used prior to 2013-07-15	Model Number With DM2	Model Name With DM2	Model Number with DM32	Model Name with DM32. "1" at the end signifies DM32	Model Number with DM32 Wi-Fi	Model Name with DM32 Wi-Fi, "2" at the end signifies DM32 with WiFi
DK200 DucTester	UK240	Model UK240 DucTester with DM-2	UK241	Model UK241 DucTester with DM32	UK242	Model UK242 DucTester with DM32 WIFI
UK200 Blower Door	UK200	Model UK200 with Cloth Panel and DM-2	UK201	Model UK201 with Cloth Panel and DM32	UK202	Model UK202 with Cloth Panel and DM32 WIFI
UK210 Blower Door Large Cloth Panel	UK210	Model UK210 with Large Cloth Panel and DM-2	UK211	Model UK211 with Large Cloth Panel and DM32	UK212	Model UK212 with Large Cloth Panel and DM32 WIFI
UK1000 Blower Door	UK1100	Model UK1100 with Cloth Panel and DM-2	UK1101	Model UK1101 with Cloth Panel and DM32	UK1102	Model UK1102 with Cloth Panel and DM32 WIFI
New UK1000 Large Cloth Panel	UK1110	Model UK1110 with Large Cloth Panel and DM-2	UK1111	Model UK1111 with Large Cloth Panel and DM32	UK1112	Model UK1112 with Large Cloth Panel and DM32 WIFI
New 2 fan UK1000 Large Cloth Panel	UK1210	Model UK1210 Double Fan with Large Cloth Panel and DM-2	UK1211	Model UK1211 Double Fan with Large Cloth Panel and DM32	UK1212	Model UK1212 Double Fan with Large Cloth Panel and DM32 WIFI
New 3 Fan UK1000 Large Cloth Panel	UK1310	Model UK1310 Triple Fan with Large Cloth Panel and DM-2	UK1311	Model UK1311 Triple Fan with Large Cloth Panel and DM32	UK1312	Model UK1312 Triple Fan with Large Cloth Panel and DM32 WIFI
Q4E	UK3100	Model UK3100 with Cloth Panel and DM-2	UK3101	Model UK3101 with Cloth Panel and DM32	UK3102	Model UK3102 with Cloth Panel and DM32 WIFI
New Q4E Large Cloth Panel	UK3110	Model UK3110 with Large Cloth Panel and DM-2	UK3111	Model UK3111 with Large Cloth Panel and DM32	UK3112	Model UK3112 with Large Cloth Panel and DM32 WIFI
New 2 fan Q4E Large Cloth Panel	UK3210	Model UK3210 Double Fan with Large Cloth Panel and DM-2	UK3211	Model UK3211 Double Fan with Large Cloth Panel and DM32	UK3212	Model UK3212 Double Fan with Large Cloth Panel and DM32 WIFI
New 3 Fan Q4E Large Cloth Panel	UK3310	Model UK3310 Triple Fan with Large Cloth Panel and DM-2	UK3311	Model UK3311 Triple Fan with Large Cloth Panel and DM32	UK3312	Model UK3312 Triple Fan with Large Cloth Panel and DM32 WIFI

Q5E	UK3120	Model UK3120 with Hard Panel and DM-2	UK3121	Model UK3121 with Hard Panel and DM32	UK3122	Model UK3122 with Hard Panel and DM32 WIFI
QMG	UK3330	Model UK3330 Triple Fan with Folding Panel and DM-2	UK3331	Model UK3331 Triple Fan with Folding Panel and DM32	UK3332	Model UK3332 Triple Fan with Folding Panel and DM32 WIFI
New System Large Cloth Panel	UK4210	Model UK4210 Double Contra Fan with Large Cloth Panel and DM-2	UK4211	Model UK4211 Double Contra Fan with Large Cloth Panel and DM32	UK4212	Model UK4212 Double Contra Fan with Large Cloth Panel and DM32 WIFI

For: 240V/50Hz, commonly used in the Europe, System Prefix = EU

Name used prior to 2013-07-15	Model Number With DM2	Model Name With DM2	Model Number with DM32	Model Name with DM32. "1" at the end signifies DM32	Model Number with DM32 Wi-Fi	Model Name with DM32 Wi-Fi, "2" at the end signifies DM32 with Wi-Fi
DE200 DucTester	EU240	Model EU240 DucTester with DM-2	EU241	Model EU241 DucTester with DM32	EU242	Model EU242 DucTester with DM32 WIFI
EU200 Blower Door	EU200	Model EU200 with Cloth Panel and DM-2	EU201	Model EU201 with Cloth Panel and DM32	EU202	Model EU202 with Cloth Panel and DM32 WIFI
EU210 Blower Door Large Cloth Panel	EU210	Model EU210 with Large Cloth Panel and DM-2	EU211	Model EU211 with Large Cloth Panel and DM32	EU212	Model EU212 with Large Cloth Panel and DM32 WIFI
EU1000 Blower Door	EU1100	Model EU1100 with Cloth Panel and DM-2	EU1101	Model EU1101 with Cloth Panel and DM32	EU1102	Model EU1102 with Cloth Panel and DM32 WIFI
New EU1000 Large Cloth Panel	EU1110	Model EU1110 with Large Cloth Panel and DM-2	EU1111	Model EU1111 with Large Cloth Panel and DM32	EU1112	Model EU1112 with Large Cloth Panel and DM32 WIFI
New 2 fan EU1000 Large Cloth Panel	EU1210	Model EU1210 Double Fan with Large Cloth Panel and DM-2	EU1211	Model EU1211 Double Fan with Large Cloth Panel and DM32	EU1212	Model EU1212 Double Fan with Large Cloth Panel and DM32 WIFI
New 3 Fan EU1000 Large Cloth Panel	EU1310	Model EU1310 Triple Fan with Large Cloth Panel and DM-2	EU1311	Model EU1311 Triple Fan with Large Cloth Panel and DM32	EU1312	Model EU1312 Triple Fan with Large Cloth Panel and DM32 WIFI
Q4E	EU3100	Model EU3100 with Cloth Panel and DM-2	EU3101	Model EU3101 with Cloth Panel and DM32	EU3102	Model EU3102 with Cloth Panel and DM32 WIFI

New Q4E Large Cloth Panel	EU3110	Model EU3110 with Large Cloth Panel and DM-2	EU3111	Model EU3111 with Large Cloth Panel and DM32	EU3112	Model EU3112 with Large Cloth Panel and DM32 WIFI
New 2 fan Q4E Large Cloth Panel	EU3210	Model EU3210 Double Fan with Large Cloth Panel and DM-2	EU3211	Model EU3211 Double Fan with Large Cloth Panel and DM32	EU3212	Model EU3212 Double Fan with Large Cloth Panel and DM32 WIFI
New 3 Fan Q4E Large Cloth Panel	EU3310	Model EU3310 Triple Fan with Large Cloth Panel and DM-2	EU3311	Model EU3311 Triple Fan with Large Cloth Panel and DM32	EU3312	Model EU3312 Triple Fan with Large Cloth Panel and DM32 WIFI
Q5E	EU3120	Model EU3120 with Hard Panel and DM-2	EU3121	Model EU3121 with Hard Panel and DM32	EU3122	Model EU3122 with Hard Panel and DM32 WIFI
QMG	EU3330	Model EU3330 Triple Fan with Folding Panel and DM-2	EU3331	Model EU3331 Triple Fan with Folding Panel and DM32	EU3332	Model EU3332 Triple Fan with Folding Panel and DM32 WIFI
New System Large Cloth Panel	EU4210	Model EU4210 Double Contra Fan with Large Cloth Panel and DM-2	EU4211	Model EU4211 Double Contra Fan with Large Cloth Panel and DM32	EU4212	Model EU4212 Double Contra Fan with Large Cloth Panel and DM32 WIFI

Enclosure Integrity

For: 120V/60Hz, commonly used in North America, System Prefix = US

Name used prior to 2013-07-15	Model Number With DM2	Model Name With DM2*	Model Number with DM32 Wi-Fi	Model Name with DM32 Wi-Fi, "2" at the end signifies DM32 with WiFi
US200F Blower Door	US200F	Model US200F with Cloth Panel and DM-2 for Enclosure Integrity	US202F	Model US202F with Cloth Panel and DM32 WIFI for Enclosure Integrity
US210F Blower Door Large Cloth Panel	US210F	Model US210F with Large Cloth Panel and DM-2 for Enclosure Integrity	US212F	Model US212F with Large Cloth Panel and DM32 WIFI for Enclosure Integrity
US1000F Blower Door	US1100F	Model US1100F with Cloth Panel and DM-2 for Enclosure Integrity	US1102F	Model US1102F with Cloth Panel and DM32 WIFI for Enclosure Integrity
New US1000F Large Cloth Panel	US1110F	Model US1110F with Large Cloth Panel and DM-2 for Enclosure Integrity	US1112F	Model US1112F with Large Cloth Panel and DM32 WIFI for Enclosure Integrity
Q4E	US3100F	Model US3100F with Cloth Panel and DM-2 for Enclosure Integrity	US3102F	Model US3102F with Cloth Panel and DM32 WIFI for Enclosure Integrity

New Q4E Large Cloth Panel	US3110F	Model US3110F with Large Cloth Panel and DM-2 for Enclosure Integrity	US3112F	Model US3112F with Large Cloth Panel and DM32 WIFI for Enclosure Integrity
New 2 fan Q4E Large Cloth Panel	US3210F	Model US3210F Double Fan with Large Cloth Panel and DM-2 for Enclosure Integrity	US3212F	Model US3212F Double Fan with Large Cloth Panel and DM32 WIFI for Enclosure Integrity
Q5E	US3120F	Model US3120F with Hard Panel and DM-2 for Enclosure Integrity	US3122F	Model US3122F with Hard Panel and DM32 WIFI for Enclosure Integrity
Q5E-2X	US3220F	Model US3220F Double Fan with Hard Panel and DM-2 for Enclosure Integrity	US3222F	Model US3222F Double Fan with Hard Panel and DM32 WIFI for Enclosure Integrity

Glossary

Term	Definition
Air Changes per Hour	<p>The number or times per hour that the volume of air in the enclosure will flow out of the enclosure. A flow rate normalized to the volume of the enclosure and allows comparison of the “leakiness” of larger volumes to the “leakiness” of smaller volumes. Always expressed in units of /h.</p> <p>Calculated as: General: Flow / Volume</p> <p>Units: $\frac{1}{h}$</p> $= \text{CFM} * \left(\frac{60 \text{ min}}{1 \text{ h}}\right) * \left(\frac{1}{\text{ft}^3}\right) = \left(\frac{\text{m}^3}{\text{h}}\right) * \left(\frac{1}{\text{m}^3}\right) = \left(\frac{\text{m}^3}{\text{s}}\right) * \left(\frac{60 \text{ s}}{1 \text{ min}}\right) * \left(\frac{60 \text{ min}}{1 \text{ h}}\right) * \left(\frac{1}{\text{m}^3}\right)$ $= \left(\frac{1}{\text{s}}\right) * \left(\frac{60 \text{ s}}{1 \text{ min}}\right) * \left(\frac{60 \text{ min}}{1 \text{ h}}\right) * \left(\frac{1 \text{ m}^3}{1000 \text{ l}}\right)$
ACH50 or ACH @ 50 Pa	Designation for “Air Changes at 50 Pa.” Can be calculated by taking CFM50 x 60 minutes/hour, divided by the house volume.
Air Current Tester	Neutrally buoyant smoke (manufactured by Retrotec) used to locate leakage locations, and to observe the direction of air flow, or to see if pressure neutralization between two zones is reached.
air leakage	Pertains to how leaky an enclosure may be: the movement/flow of air through the building envelope, which is driven by either or both positive (infiltration) or negative (exfiltration) pressure differences or test pressures across the building envelope.
Baseline pressure	<p>Pressure that exists when the enclosure has been prepared for the test, but before the fan pressurization system is activated. There is always some Baseline pressure due to stack, wind, flues and active HVAC systems. There are two components of Baseline pressure. A fixed Baseline offset (usually due to stack or HVAC) and a fluctuating pressure (usually due to wind or elevator operation). A method of determining Baseline pressure is to have a digital gauge accumulate readings over an adjustable time period</p> <p>(Note: The terms “static pressure”, “bias pressure,” and “zero Fan Pressure difference” are used interchangeably with the term Baseline pressure in other documents/standards used in the industry.)</p>
CFM50 or CFM @ 50 Pa	Flow rate, in cubic feet per minute, required to depressurize/pressurize the building to 50 Pascals
Conditioned Space	An area or volume that is normally air-conditioned or heated (i.e. inside the thermal envelope). Even though supply ducts may not discharge directly into these spaces, they are considered “conditioned” if their temperature follows indoor temperature closer than outdoor. (e.g. Any space maintained above 50 °F in winter and below 80 °F in summer)
depressurization	The process of creating a negative pressure in the enclosure by blowing air out of it. Air is drawn in from outside to replace it, showing up as “geysers” when checked with an air current tester.
digital gauge	A gauge with an electronic pressure sensor and digital display that is capable of reading in tenths of a Pascal.
Door Fan	<p>A test instrument that fits into an open doorway in order to pressurize or depressurize an enclosure. It is a calibrated fan capable of measuring air-flow, and is used while mounting it into a doorway.</p> <p>A Door Fan is often called a “Blower Door” or an “Infiltrometer™”. Door fan is more linguistically correct than the common term “blower door”, since it is not a “door,” but rather a “fan” and since it does not use a “blower.”</p>
Door Panel	A solid or flexible panel used to temporarily seal off a door way while allowing for the installation of a fan for the purpose of blowing air into the building in order to measure the air leakage rate or to provide a pressure to assist in the location of air leaks

Term	Definition
Effective Leakage Area (EfLA)	A common term used to describe air flow at a pressure by equating it to an equivalent size hole in an elliptical nozzle that would pass the same air flow at the same test pressure. It is usually taken at 4 Pa and incorporates a 1.0 discharge coefficient. It is typically about half the size of an equivalent leakage area that describes the same air flow rate. See ASTM E779-10, eq. (5).
EfLA	See “ Effective Leakage Area ”
enclosure	A room, house, or building. For rooms or interior spaces, the enclosure is the surface bounding a volume which is connected to outdoors directly. For example in an apartment whose only access to outdoors was through a doorway that leads directly outdoors, the enclosure is formed by the walls of the apartment. If a building has a series of apartments or offices whose only access to the outdoors is through a common hallway then the enclosure would be the volume that bounds all of the apartments or offices.
Envelope	The surfaces composed of floor and walls and floors that separate the test volume from volume surrounding the test volume. Also see” enclosure ”
EqLA	See “ Equivalent Leakage Area ”
Equivalent Leakage Area (ELA or EqLA)	In layman’s terms, the ELA is the size of hole we’d have if all the building’s cracks and holes could somehow be brought together. In Engineer’s terms: the equivalent size of hole required in a flat plate to give the same flow rate having a discharge coefficient of 0.61 and taken at the Reference Pressure. This ELA is sometimes called the EqLA or Canadian ELA because it was first used in the Canadian GSB air leakage standard for houses. This ELA enjoys worldwide acceptance by most testers, even in the US. This ELA should not be confused with another ELA that is often called the EfLA or Effective Leakage Area. It is very unfortunate that both these ELA’s have the same acronym of ELA. The EfLA was developed for the US ASTM Standard and is smaller than the EqLA by at least a factor of 0.61 because it uses a discharge coefficient of 1.0. This EfLA is sometimes called the LBL or Lawrence Berkley Labs ELA because it was developed there and is used in the LBL natural air change model that enjoys wide usage- apart from that usage, the EfLA is not used very much but the existence of both can create discrepancies in results that may confuse users. When it is taken at a reference pressure of 75 Pa, it is often referred to as EqLA75. EqLA is typically about twice the size of an Effective Leakage Area that describes the same air flow rate. See ASTM E779-10, eq. (5).
Fan Pressure	The pressure difference between inside the door fan and the surrounding air. This pressure can be read as “PrB” from Channel B on the DM-2. It is used by the computer to calculate the air flow rate through the Door Fan.
HVAC	Heating Ventilating and Air conditioning system.
induced pressure	The pressure difference created by the Door Fan (Test Fan) between inside and outside of the enclosure. This pressure is commonly measured on Channel A of the pressure gauge.
Leakage	A general term used to describe holes or the area of holes in or around an enclosure
Leakage Area	This is the same as “Equivalent Leakage Area” but is not specific as to which kind of leakage
Open Range	A Range configuration on a Retrotec Door Fan – indicates that no Range Rings or Range Plates are attached. It is sometimes referred to as Open (22) Range since its diameter is 22 inches.
outdoors	Outside the building in the area around the building.
Manual Speed Control Knob	The dial that is on a Fan Top to control fan speed
Manual Speed Control Accessory	Separate fan speed controller with a knob to control the speed, provided as an optional accessory if user does not want to use a gauge as speed controller

Term	Definition
Pascal (Pa)	Often shown as “Pa”. A very small metric unit of pressure. There are 249 Pascals in 1 inch of Water Column (the pressure required to push water up 1” in a tube). One Pascal = 0.000145 psi.
Pressurization	The process of creating a positive pressure in the house by blowing air into the enclosure. Air is pushed out through all the leaks, causing the smoke to move away from the operator when checked with an air current tester
Range configuration	The Range Plate or Range Ring that is used on the fan during a Door Fan test. See Retrotec’s Fan Range Configuration QuickGuide
Range Plate	The Range attachment on the Retrotec Door Fan, which holds Ranges C8, C6, C4, C3, C2, C1, L4, L2, and L1. See Retrotec’s Fan Range Configuration QuickGuide.
Range Ring	The plastic Range attachments on the Retrotec Door, which include Range A and Range B. See Retrotec’s Fan Range Configuration QuickGuide.
Reading	A set of simultaneous Induced (Room) Pressure and Fan Pressure readings. Sometimes referred to as a data set or test point because it is plotted as one point on a graph.
Reference Pressure	The pressure at which a result is calculated. This is usually at the test pressure. For example EqLA is typically referenced to 10 Pa. EqLA is also taken at 25 Pa for some purposes because it tends to be more repeatable. Forced Air Changes per Hour (ACH) are usually referenced to 50 Pa, which is why it is common to see ACH50 for air changes at 50 Pa. CFM50 would be the airflow at 50 Pa. In all cases the test may be taken at a pressure close to the reference pressure and then, using a computer, can be extrapolated to calculate the result that would have been observed, had the target reference pressure been achieved.
Room Pressure	The pressure difference created by the Door Fan between inside and outside of the enclosure. (See also “induced pressure”). This pressure is commonly measured by Channel A on the gauge.